

STORM WATER QUALITY  
**BEST MANAGEMENT PRACTICES MANUAL**  
for construction and land disturbing activities

2018



The City of  
**OKLAHOMA CITY**  
Public Works



THE CITY OF OKLAHOMA CITY

APPROVAL SHEET

BEST MANAGEMENT PRACTICES MANUAL  
FOR CONSTRUCTION AND LAND DISTURBING ACTIVITIES

Prepared by:

Storm Water Quality Management

420 W Main, Suite 360

Oklahoma City, Oklahoma 73102

APPROVED by the City of Oklahoma City this 18 day of December, 2018.

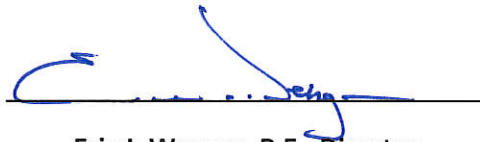

Eric J. Wenger, P.E., Director

Public Works/City Engineer

# TABLE OF CONTENTS

- 1. Introduction**
  - 1.1 Background
  - 1.2 About This BMP Manual
  - 1.3 Introduction to BMPs
    - 1.3.1 Non-Structural BMPs
    - 1.3.2 Structural BMPs
  - 1.4 BMP Minimum Regulatory Requirements
  - 1.5 Disclaimer
  
- 2. Contacts/Websites**
  - 2.1 U. S. Environmental Protection Agency (EPA)
  - 2.2 U.S. Army Corps of Engineers/Oklahoma –Tulsa District
  - 2.3 Oklahoma Department of Environmental Quality (ODEQ)
  - 2.4 City of Oklahoma City - Public Works Department
  - 2.5 City of Oklahoma City - Storm Water Quality Division (SWQ)
  
- 3. Oklahoma City Municipal Code – Chapter 48**  
**Article II. Grading, Erosion and Sediment Control**
  - 3.1 Chapter 48 – 15 Definitions
  - 3.2 Chapter 48 – 16 Permit Application Requirements and Procedures
  - 3.3 Chapter 48 – 17 Implementation and Enforcement Procedures
  - 3.4 Chapter 48 – 18 Penalty
  - 3.5 Chapter 48 – 19 General Land Disturbing Activity
  - 3.6 Chapter 48 – 20 Land Disturbing Activity Regulated
  - 3.7 Chapter 48 – 21 Land Disturbing Permit
  - 3.8 Chapter 48 – 22 Permit Application
  - 3.9 Chapter 48 – 23 Sediment and Erosion Control
  
- 4. Permitting Process**
  - 4.1 Obtaining a Permit
  - 4.2 Contractor Certification
  - 4.3 Terminating Storm Water Constuction/Land Disturbing Permit
  - 4.4 Re-inspection Fee
  
- 5. BMP Inspection and Maintenance**
  - 5.1 Inspection and Maintenance Report
  - 5.2 Inspection and Maintenance Record Keeping
  - 5.3 Inspection Frequency/Schedule
  - 5.4 Maintenance Period
  - 5.5 Responsible Person
  - 5.6 Certification Statement
  - 5.7 Sample Inspection Report

## **6. Forms**

- 6.1 OKC-SWQ Form C-1 – Notice of Intent (NOI)
- 6.2 OKC Form – SWPPP for Less Than One (1) Acre of Disturbed Area
- 6.3 OKC-SWQ Form C2 – Notice of Termination (NOT)
- 6.4 Contractor Certification Form
- 6.5 DEQ-From 605-002A – Notice of Intent (NOI)
- 6.6 DEQ Form 605-003 – Notice of Termination (NOT)
- 6.7 EPA SWPPP Template Form
- 6.8 Corrective Action Report
- 6.9 Employee Training Report

## **7. Best Management Practices Detail Sheets**

- 7.1 Silt Fence
- 7.2 Triangular Silt Dikes
- 7.3 Straw Wattle Installation
- 7.4 Temporary Rock Construction Entrance/Exit
- 7.5 Temporary Rock Construction Entrance/Exit for Steep Grades
- 7.6 Rock Bag Silt Fence
- 7.7 Rock Check Dams
- 7.8 Rock Bag Check Dams
- 7.9 Rock Bag Curb Inlet Barrier
- 7.10 Rock Bag/Filter Mat Drop Inlet Sediment Barrier
- 7.11 Curb Inlet Filter Mat Sediment Barrier
- 7.12 Curb Inlet Sediment Bag
- 7.13 Drop Inlet Sediment Bag
- 7.14 New Roadways
- 7.15 Concrete Flume
- 7.16 Erosion Blanket & Turf Reinforcement Mats – Slope Installation
- 7.17 Erosion Blanket & Turf Reinforcement Mats – Channel Installation
- 7.18 Energy Dissipater
- 7.19 Typical Sediment Basin
- 7.20 Typical Earth Dike
- 7.21 Subsurface Concrete Washout Area
- 7.22 Above Ground Concrete Washout Area
- 7.23 Silt Sock Installation

## **8. Other BMPs**

- 8.1 Hydromulching
- 8.2 Coagulation and Flocculation
- 8.3 Temporary Above Ground Storage Tanks (ASTs)

# 1 INTRODUCTION

## 1.1 Background

On September 9, 1992, the US Environmental Protection Agency (EPA) issued regulations which require water discharges associated with construction activities to be authorized by permit through the National Pollution Discharge Elimination System (NPDES). The City of Oklahoma City Department of Public Works began to implement the NPDES Storm Water program in 1992. By 1995, The City had completed the required preliminary research and development and was issued an EPA NPDES Storm Water Discharge Permit. On September 9, 1997, two years after the initial permit issuance, EPA delegated NPDES permitting authority to the Oklahoma Department of Environmental Quality (ODEQ) as it relates to storm water discharges. The City currently operates under an ODEQ Municipal Separate Storm Sewer System (MS4) Storm Water Discharge permit (OKS000101).

## **1.2 About This Best Management Practices Manual (BMP Manual)**

The purpose of this manual is to assist engineers, developers, owners, operators, and contractors in determining what storm water regulations apply to their situation, what the appropriate Best Management Practices (BMPs) are to meet the regulation, and how to design and maintain storm water BMPs. This BMP Manual is intended to provide the information necessary to properly comply with the requirements of the Oklahoma City Municipal Code, and the storm water BMPs that meet State water quality objectives. However, it does not cover every aspect of civil engineering and structural design, nor does it cover every site situation that may occur or every possible storm water solution. The site operator is responsible for the design and construction of properly functioning storm water BMPs that meet all of the applicable regulations, including the water quality objectives. The site operator must also consider all the unique conditions of an individual site. Where the site operator determines that conformance with this manual would create an unreasonable hardship or where an alternative design may be more appropriate, alternative designs, materials, and methodologies will be considered on a case-by-case basis.

This BMP Manual is intended to supplement Oklahoma City Municipal Code by explaining the storm water BMPs that will be accepted, along with their design criteria. Local municipalities are given the freedom to adopt more stringent requirements than Federal and State regulations. In general, if any part of this BMP manual lists requirements different from those imposed by any other ordinance, rule, regulation, or other provision of law, whichever provision is more restrictive or imposes higher protective standards for human or environmental health, safety, and welfare shall have control. The intention is to provide the reader with visual assistance in device functions, installation concepts, as well as guidance on designing, operating, and maintaining specific BMPs. Knowledge about storm water management is continually advancing. This BMP Manual, or individual sections of this BMP Manual, will be regularly updated as advances in research and practices are identified.

## **1.3 Introduction to BMPs**

All development, construction, grading, clearing and grubbing, excavation and stockpiling, preparation for planting, excavation of trenches, demolition, or any activity which results in the disturbance of soil or vegetative cover within the City, or in any area under the jurisdiction of the City, shall be performed in a manner consistent and in compliance with the requirements of Oklahoma City Municipal Code.

Storm water BMPs are implemented as a way of treating or limiting pollutants and other damaging effects of storm water runoff in order to meet Federal, State and local regulations. There are two major categories of BMPs: non-structural and structural.

### 1.3.1 Non-Structural BMPs

Non-structural BMPs are typically passive, or programmatic, and tend to be source control or pollution prevention BMPs that reduce pollution in runoff by reducing the opportunity for the storm water runoff to be exposed to the pollutants. In many circumstances, it may be easier and less costly to prevent the pollutants from entering the drainage system rather than to control them with end-of-pipe structural BMPs. Used properly, the non-structural BMPs can be very effective in controlling pollutants and will greatly reduce the need for structural BMPs. In addition, non-structural BMPs tend to be less costly and easier to design, program and implement. Typically, the measures do not require maintenance but do require administrative resource commitments to ensure that they are continually implemented. Non- structural BMPs normally do not have technical or engineering designs associated with them.

Typical non-structural BMPs include:

- Public education and participation.
- Land use planning and management (vegetative controls, reduced impervious areas, disconnected impervious areas).
- Material use controls (housekeeping practices, safer alternative products, pesticide and fertilizer use).
- Material exposure controls (material storage control, vehicle-use reduction).
- Spill prevention and cleanup (vehicle spill control, aboveground tank spill control).
- Connection controls (illicit connection detection, removal, and prevention, leaking sanitary sewer control).
- Street and storm drain maintenance (roadway cleaning, catch basin cleaning, vegetation controls, roadway/bridge maintenance, drainage channel and creek maintenance).
- Good Housekeeping - common problem areas include around trash containers and storage areas. BMPs must ensure that waste, garbage and floatable debris are not discharged to receiving waters.
- Prior to commencement of earth disturbing activities, or pollutant generating activities, whichever occurs first. Permittee must ensure personnel understand the requirements of this permit and document the training (see form 6.9).
- Preventive Maintenance - a site must have a preventive maintenance program which includes routine inspections and maintenance of existing BMPs.

### 1.3.2 Structural BMPs

Structural BMPs refer to physical structures designed to remove pollutants from storm water runoff, reduce downstream erosion, provide flood control, and promote groundwater recharge. Structural BMPs typically require engineering design and engineered construction. The various types of structural BMPs vary greatly in their design and they each have advantages and disadvantages relative to each other. Some structural BMPs provide considerable storm water quantity handling capability through the use of infiltration and/or detention/retention facilities (e.g. infiltration devices, storm water wetlands, wet detention basins). Others provide many types of pollutant removal mechanisms such as sedimentation, filtration, microbial action, and plant uptake (e.g. bioretention, storm water wetlands). Some BMPs provide high levels of both storm water quantity handling and pollutant removal ability. In addition, structural BMPs can be divided into those that help reduce the pollutants or quantity of storm water entering a collection system (e.g. permeable pavement, filter strips, rooftop runoff management), and those that treat the storm water at the "end of the pipe" (e.g. sand filter, storm water wetlands, wet detention basins).



Typical structural BMPs Include:

- Bioretention
- Sand Filter
- Storm Water Wetlands
- Wet Detention Basin
- Filter Strip
- Grassed Swale
- Infiltration Devices
- Restored Riparian Buffer
- Dry Extended Detention Basin
- Permeable Pavement Systems
- Rooftop Runoff Management
- Proprietary Systems (vortex separators, catch basin inserts, chemical treatment systems)

#### **1.4 BMP Minimum Regulatory Requirements**

It is believed that following the conditions of the BMP Manual will provide compliant and permissible design; some professionals may desire to design storm water treatment devices in a manner different from that specified in the BMP Manual. This practice is acceptable if the design and implementation meet the state's minimum regulatory requirements and can be shown to provide equal or better protection than those specified in the BMP Manual. Design professionals desiring to deviate from the provisions contained in this BMP Manual must provide full technical justification that their recommendation is as protective as, or better, than the recommendations contained in this BMP Manual. Vague, anecdotal or isolated evidence of the acceptability of an alternative solution cannot be used to supplant the considered recommendations of this BMP Manual.

#### **1.5 Disclaimer**

To the best of their ability, the authors have insured that material presented in this manual is accurate and reliable. The design of engineered facilities, however, requires considerable judgment on the part of designer. It is the responsibility of the design professional to insure that techniques utilized are appropriate for a given situation. Therefore, the City, nor any author or other individual associated with production of this manual, accepts any responsibility for any loss, damage, or injury as a result of the use of this BMP Manual.

This BMP Manual does not represent, and should not be construed to represent, the endorsement of any BMP product or company.

# 2

## CONTACTS/WEBSITES

### **2. Contacts/Websites**

- 2.1 U.S. Environmental Protection Agency (EPA)
- 2.2 U.S. Army Corps of Engineers/Oklahoma-Tulsa District
- 2.3 Oklahoma Department of Environmental Quality (ODEQ)
- 2.4 City of Oklahoma City – Public Works Department
- 2.5 City of Oklahoma City – Storm Water Quality Division (SWQ)

## **2.1 U.S. Environmental Protection Agency (EPA)**

Storm water runoff is generated when precipitation from rain or snowmelt events flow over land or impervious surfaces and does not percolate into the ground. As the runoff flows over the land or impervious surfaces (e.g. paved streets, parking lots, or building rooftops), it accumulates debris, chemicals, sediment or other contaminants that could adversely affect water quality. In addition, most storm water discharges are considered point sources and require coverage under an NPDES permit. For more information visit [www.epa.gov](http://www.epa.gov)

## **2.2 U.S. Army Corps of Engineers/Oklahoma -Tulsa District**

In Oklahoma, the issue of “Waters of the United States” and “Wetlands” falls under the U. S. Army Corps of Engineers (COE) Tulsa District Regulatory Division. The City is obligated to insure that all necessary State and Federal Permits have been obtained, pursuant to 44 CFR 60.3. Therefore, if the USGS 7.5 Minutes Quadrangle maps indicate that “Waters of the United States” or “Wetlands” exist within the project, the applicant is required to submit documentation from the COE detailing COE approval for proposed work. For more information visit [www.swt.usace.army.mil](http://www.swt.usace.army.mil)

## **2.3 Oklahoma Department of Environmental Quality (ODEQ)**

As of September 9, 1997, EPA delegated the NPDES MS4 permitting authority for storm water discharges associated with construction and industrial sites in the State of Oklahoma to the Department of Environmental Quality. Visit [www.deq.state.ok.us/wqdnew/stormwater/constructions/index.html](http://www.deq.state.ok.us/wqdnew/stormwater/constructions/index.html)

## **2.4 City of Oklahoma City – Public Works Department**

The mission of the Public Works Department is to provide infrastructure construction and maintenance, private construction review and inspection, and emergency first response services to the public so they can live, work and play in a safe and functional environment. Or visit [www.okc.gov/pw](http://www.okc.gov/pw)

## **2.5 City of Oklahoma City – Storm Water Quality Division (SWQ)**

The Storm Water Quality Division provides inspections, enforcement, water quality assessments, public outreach and household hazardous waste services to residents, businesses, and government agencies so they can comply with the Clean Water Act and enjoy a safe and clean environment. For more information about the Storm Water Quality Division, visit [www.okc.gov/swq](http://www.okc.gov/swq)

# 3

## MUNICIPAL CODES

- 3. Oklahoma City Municipal Code - Chapter 48 Article II. Grading, Erosion and Sediment Control**
  - 3.1 Chapter 48 – 15 Definitions
  - 3.2 Chapter 48 – 16 Permit Application Requirements and Procedures
  - 3.3 Chapter 48 – 17 Implementation and Enforcement Procedures
  - 3.4 Chapter 48 – 18 Penalty
  - 3.5 Chapter 48 – 19 General Land Disturbing Activity
  - 3.6 Chapter 48 – 20 Land Disturbing Activity Regulated
  - 3.7 Chapter 48 – 21 Land Disturbing Permit
  - 3.8 Chapter 48 – 22 Permit Application
  - 3.9 Chapter 48 – 23 Sediment and Erosion Control

### 3.1 Chapter 48 – 15 Definitions

The following words, terms and phrases, when used in this chapter, shall have the meanings ascribed to them in this section, except where the context clearly indicates a different meaning:

**Best management practices:** a technique or series of techniques which, when used in an erosion control plan, is proven to be effective in controlling construction-related runoff, erosion and sedimentation.

**City Engineer:** the professional engineer designated in Section 2-111 of this Code.

**Civil engineering:** the application of the knowledge of the forces of nature, principles of mechanics and the properties of materials to the evaluation, design and construction of civil works for the beneficial uses of mankind.

**ODEQ:** The Oklahoma Department of Environmental Quality

**Engineering geologist:** a geologist experienced and knowledgeable in engineering geology and certified by the State of Oklahoma to practice engineering geology.

**Engineering geology:** the application of geologic knowledge and principles in the investigation and evaluation of naturally occurring rock and soil for use in the design of civil works.

**EPA:** The United States Environmental Protection Agency.

**Erosion:** the wearing away of the ground surface as a result of the movement of wind, water and/or ice.

**Erosion and sediment control site plan or erosion plan:** a set of best management practices or equivalent measures designed to control surface runoff and erosion and to retain sediment on a particular site during the period in which pre-construction and construction-related land disturbance, fills and soil storage occur, and before final improvements are completed.

**Excavation:** to expose or uncover by digging, scooping, or removing soil.

**Grade:** the vertical location of the ground surface.

**Grading:** any land disturbance or land fill, or combination thereof.

**Grading plan:** an approved plan for grading a site.

**Land disturbing activity/land disturbance:** any land change which may result in soil erosion from water and wind and the movement of sediments into community waters or onto lands and roadways within the community, including, but not limited to, clearing, dredging, grading, excavating, transporting, storing, stockpiling, mining, disposing, and filling of soil, earthen materials, or land.

**Land fill:** any human activity involving the disposition of soil or other earth materials.

**Manager or Storm Water Quality Manager:** the person designated by the City to supervise the operation of Storm Water Quality Management Division of the Public Works Department.

**Mine:** a pit or excavation in the earth from which mineral substances are taken.

**Mining:** the extraction of minerals from natural deposits by any method or process for remuneration.

**Permanent improvements:** site improvements other than erosion control measures to be constructed after clearing and grading activities have been completed.

**Permittee:** the applicant in whose name a valid permit is duly issued pursuant to this article and his/her agents, employees and others acting under his/her supervision or control.

**Public Works Director or Director:** the person designated in Section 2-542 of this Code.

**Sediment:** earth material deposited by water or wind.

**Site:** a parcel or parcels of real property owned by one or more than one person which is being or is capable of being developed as a single project.

**Soil:** naturally occurring superficial deposits overlaying bedrock.

**Soil engineer:** a civil engineer experienced and knowledgeable in the practice of soil engineering.

**Soil engineering:** the application of the principles of soil mechanics in the investigation, evaluation and design of civil works involving the use of earth materials and the inspection and testing of the construction thereof.

(Ord. No. 21320, § 1, 9-28-99; Ord. No. 24076, § 1, 6-15-10)

### **3.2 Chapter 48 – 16 Permit Application Requirements and Procedures**

- (a) Land disturbing activities - Requiring a permit. No person may perform any land disturbing activity, or cause or allow any land disturbing activities on land owned or controlled by such person without first obtaining a valid site-specific permit. All land disturbing activities must be performed in accordance with this chapter.
- b) Land disturbing activities - Not requiring a permit. However, the following land disturbing activities shall not require a permit:
  - (1) such minor land disturbing activities as home gardens and individual home landscaping, home repairs, home maintenance work, and other related activities which result in minor soil erosion;
  - (2) the construction of single-family residences when built separately on lots less than one acre not within a subdivision, and have been issued building permits; provided that excavation is limited to trenches for the foundation, basements, service and sewer connections, and minor grading for driveways, yard areas and sidewalks, with no offsite discharge of pollutants;

- (3) individual service and sewer connections for single-or two-family residences;
- (4) agricultural practices involving the establishment, cultivation or harvesting of products of the field or orchard, preparing and planting of pasture land, forestry land management practices including harvesting, farm ponds, dairy operations, and livestock and poultry management practices, and the construction of farm buildings;
- (5) installation, maintenance and repair of any underground public utility lines when such activity occurs on an existing hard-surface road, street or sidewalk, provided the activity maintains pollution control and is confined to the area of the road, street or sidewalk which is hard-surfaced and a street, curb, gutter, or sidewalk permit has been obtained; and
- (6) construction, repair or rebuilding of tracks of a railroad company.

However, the persons conducting these permit excluded land disturbing activities shall remain responsible for otherwise conducting those activities in accordance with all other provisions of this article and other applicable laws including responsibility for controlling sedimentation and runoff.

- (c) Fees. There is hereby levied a schedule of fees for all permit services and requirements. The schedule of such fees shall be as established in Chapter 60, the General Schedule of Fees. Permit fees will be submitted to the Storm Water Quality Division of the Public Works Department and checks shall be payable to the City Treasurer.
- (d) Permit duration.
  - (1) The permit shall be for a term of one year subject to the conditions set forth in this article and on the permit.
  - (2) Should the permittee need to extend the permit beyond its original one-year term, then prior to the expiration of the current permit term, the permittee must apply for renewal of the permit and must pay a renewal fee. Permits may be renewed for an additional one-year term subject to the conditions set forth in this article and on the permit.
  - (3) Until the permitted activity is completed and the permit site meets City standards, permittee must maintain a current permit by:
    - (A) complying with the terms of the permit and this article; and
    - (B) annually before the anniversary date of the issuance of the original permit, apply for and procure a renewal of the permit.
  - (4) Failure to timely renew a permit required hereunder will result in late fees.
  - (5) Permittee must pay all fees as a condition of completion of the permitted project, including:
    - (A) permit renewal; and
    - (B) late fees; and
    - (C) re-inspection fees.
- (e) Application. The permittee must submit an application including all required forms, maps, plans, and schedules to the Director or designee for approval prior to the issuance of the permit. The permittee must resubmit such application to continue or renew the permit.
- (f) Commencement and continuation of permit activities and permit expiration.
  - (1) If the work described in any permit issued pursuant to this article has not begun within six months from the date of issuance thereof, said permit will expire.

- (2) If permittee has not so commenced, then the permit shall expire and no permit activities may be performed on that site until the Director or designee authorizes a new permit.
  - (3) Whenever a permit expires, the permittee must resubmit all required application forms, maps, plans, and schedules to the Director or designee except where an item to be resubmitted is expressly waived by the Director or designee in writing. In addition, the permittee must pay all required fees.
- (g) Maintenance period.
- (1) Stabilization measures shall be initiated within 14 days after the construction activity in that portion of the site has temporarily or permanently ceased unless earth disturbing activities on a portion of the site will be resumed within 21 days, temporary stabilization measures do not have to be initiated on that portion of the site. Stabilization measures must be in accordance with standards approved by the Director or designee. Permittee must diligently continue and maintain such stabilization measures until a Notice of Termination has been accepted by the Director or designee
  - (2) Upon completion of construction activities, permittee must stabilize the entire site by planting, growing and establishing a uniform perennial vegetative cover until a density of at least 70 percent of the native background cover has been established for all unpaved areas. When the site has been finally stabilized, permittee must submit a signed Notice of Termination to the Director or designee for review.
  - (3) The permittee must maintain the site, the stabilization controls, and erosion controls in a safe condition and in compliance with City ordinances until final inspection has been completed and Notice of Termination has been accepted by the Director or designee.
- (h) Inspections. Should permittee request an inspection and should permittee or the site be unprepared for such inspection or should the permittee or the site fail such inspection, then permittee must pay a re-inspection fee and request an additional inspection.
- (i) Enforcement.
- (1) It is a violation for any person to clear, grade, fill, excavate, store, mine, dispose of soil and earth materials, perform any other land-disturbing or land-filling activity, or cause or allow any such activities without a current valid site-specific permit therefore.
  - (2) It is a violation for any property owner to authorize any person to clear, grade, fill, excavate, store, mine, dispose of soil and earth materials, perform any other land-disturbing or land-filling activity, or cause or allow any such activities without a current valid site-specific permit therefore.
  - (3) In addition, if permittee allows a permit to expire or fails to timely procure renewal of a permit, then the Director or designee may suspend any soil disturbing or construction activities at the site by permittee and its successors, contractors, and agents; however such suspension will not relieve the permittee's obligations to maintain the site in a safe condition and in compliance with City ordinances.
  - (4) If the Director or designee determines that permittee has failed to comply with any conditions of the permit, then the Director or designee may suspend any soil disturbing or construction activities at the site by permittee and its successors, contractors, and agents; however such suspension will not relieve the permittee's obligations to maintain the site in a safe condition and in compliance with City ordinances.

(Ord. No. 21320, § 1, 9-28-99; Ord. No. 24076, § 1, 6-15-10)



### 3.3 Chapter 48 – 17 Implementation and Enforcement Procedures

- (a) Issuance of permits. The Director shall issue a permit upon notice of a grading plan and an erosion and sediment control site plan on record. A permit may be issued subject to the following conditions:
  - (1) the permittee shall maintain a copy of the permit, NPDES permit where required, approved plans and reports required under DEQ (GP-0005, Part II, B) on the work site and available for inspection during all working hours; and
  - (2) the permittee shall, at all times, be in conformity with approved grading plan and erosion and sediment control plan.
- (b) Implementation of permits-permittee's duties. Unless this requirement is waived by the Director, the permittee shall notify the Manager within 72 hours of:
  - (1) the beginning of the permitted activity;
  - (2) readiness of the site for an interim inspection, including but not limited to the installation of all interim erosion control measures;
  - (3) the completion of rough grading;
  - (4) the completion of finished grading;
  - (5) readiness of the site for final inspection, including, but not limited to, finished grading, installation of drainage devices and final erosion control measures.
- (c) Implementation of permits.
  - (1) the Director shall review all reports submitted by permittee. The Director shall have the authority to require permittee to modify the grading plan, erosion and sediment control plan, control site plans, and maintenance methods and schedules. The Director shall notify the permittee in writing of the requirement and specify a reasonable period of time within which permittee must comply. All modifications of such reports shall be subject to the Director's approval.
  - (2) the Director or representative may inspect the site at any of the following times under provision of DEQ (GP-005, Part V, N):
    - (a) upon receipt of a report by permittee;
    - (b) to verify completion of modifications required;
    - (c) during and following any rainfall, or
    - (d) at any other time, at the Director's discretion.
  - (3) the Manager shall inspect the site upon completion of interim erosion control measures, pursuant to Section 57-161(k).
  - (4) the Manager shall inspect the site upon completion of final erosion control measures, pursuant to Section 57-161(n).
  - (5) finalizing permit:
    - (a) where permanent improvements have been constructed, the permit shall be made final upon approval of the final inspection by the Manager.
    - (b) where no improvements are planned, the permit will continue in duration for one calendar year beyond the approval of the final inspection by the Manager.
      - (i) where no improvements are planned, the Manager shall visit the site during the maintenance period after final inspection. Such maintenance period shall be for a reasonable time established by the Manager. The Manager shall note deficiencies in the final erosion control measures and report same in writing to permittee and specify a reasonable period of time within which permittee must comply.

- (ii) after the maintenance period has elapsed, and the permittee has performed all maintenance as required by the Manager, the Manager shall finalize the permit and notify the permittee of the same in writing.
  - (d) Suspension or revocation of permit. The Manager shall first have resorted to the procedures set forth in this subsection before any other enforcement procedure set forth in this article.
    - (1) the Manager may suspend the permit and issue a stop work order, and permittee shall cease all work on the work site, except work necessary to remedy the cause of the suspension, upon notification of such suspension when:
      - (a) the Manager determines that the permit was issued in error or on the basis of incorrect information supplied, or in violation of any ordinance or regulation or the provisions of this article;
      - (b) permittee fails to submit reports when required under this article;
      - (c) inspections by the Manager under this article reveals that the work or the work site:
        - (i) is not in compliance with the conditions set forth in this article;
        - (ii) is not in conformity with the grading plan or erosion control plan as approved or as modified under this article; or
        - (iii) is not in compliance with an order to modify this article.
    - (2) if permittee fails or refuses to cease work, as required under this article, after suspension of the permit and receipt of a stop work order and notification thereof, the Manager may revoke the permit and issue a stop work order, and, if a stop work order is issued, the permittee shall cease work.
    - (3) the Manager may reinstate a suspended permit upon permittee's correction of the cause of the suspension.
    - (4) the Manager may not reinstate a revoked permit.
- (Ord. No. 21320, § 1, 9-28-99)

### **3.3 Chapter 48 – 17 Implementation and Enforcement Procedures**

- (a) Issuance of permits. The Director shall issue a permit upon notice of a grading plan and an erosion and sediment control site plan on record. A permit may be issued subject to the following conditions:
  - (1) the permittee shall maintain a copy of the permit, NPDES permit where required, approved plans and reports required under DEQ (GP-0005, Part II, B) on the work site and available for inspection during all working hours; and
  - (2) the permittee shall, at all times, be in conformity with approved grading plan and erosion and sediment control plan.
- (b) Implementation of permits-permittee's duties. Unless this requirement is waived by the Director, the permittee shall notify the Manager within 72 hours of:
  - (1) the beginning of the permitted activity;
  - (2) readiness of the site for an interim inspection, including but not limited to the installation of all interim erosion control measures;
  - (3) the completion of rough grading;
  - (4) the completion of finished grading;
  - (5) readiness of the site for final inspection, including, but not limited to, finished grading, installation of drainage devices and final erosion control measures.

- (c) Implementation of permits.
- (1) the Director shall review all reports submitted by permittee. The Director shall have the authority to require permittee to modify the grading plan, erosion and sediment control plan, control site plans, and maintenance methods and schedules. The Director shall notify the permittee in writing of the requirement and specify a reasonable period of time within which permittee must comply. All modifications of such reports shall be subject to the Director's approval.
  - (2) the Director or representative may inspect the site at any of the following times under provision of DEQ (GP-005, Part V, N):
    - (a) upon receipt of a report by permittee;
    - (b) to verify completion of modifications required;
    - (c) during and following any rainfall, or
    - (d) at any other time, at the Director's discretion.
  - (3) the Manager shall inspect the site upon completion of interim erosion control measures, pursuant to Section 57-161(k).
  - (4) the Manager shall inspect the site upon completion of final erosion control measures, pursuant to Section 57-161(n).
  - (5) finalizing permit:
    - (a) where permanent improvements have been constructed, the permit shall be made final upon approval of the final inspection by the Manager.
    - (b) where no improvements are planned, the permit will continue in duration for one calendar year beyond the approval of the final inspection by the Manager.
      - (i) where no improvements are planned, the Manager shall visit the site during the maintenance period after final inspection. Such maintenance period shall be for a reasonable time established by the Manager. The Manager shall note deficiencies in the final erosion control measures and report same in writing to permittee and specify a reasonable period of time within which permittee must comply.
      - (ii) after the maintenance period has elapsed, and the permittee has performed all maintenance as required by the Manager, the Manager shall finalize the permit and notify the permittee of the same in writing.
- (d) Suspension or revocation of permit. The Manager shall first have resorted to the procedures set forth in this subsection before any other enforcement procedure set forth in this article.
- (1) the Manager may suspend the permit and issue a stop work order, and permittee shall cease all work on the work site, except work necessary to remedy the cause of the suspension, upon notification of such suspension when:
    - (a) the Manager determines that the permit was issued in error or on the basis of incorrect information supplied, or in violation of any ordinance or regulation or the provisions of this article;
    - (b) permittee fails to submit reports when required under this article;
    - (c) inspections by the Manager under this article reveals that the work or the work site:
      - (i) is not in compliance with the conditions set forth in this article;
      - (ii) is not in conformity with the grading plan or erosion control plan as approved or as modified under this article; or
      - (iii) is not in compliance with an order to modify this article.

- (2) if permittee fails or refuses to cease work, as required under this article, after suspension of the permit and receipt of a stop work order and notification thereof, the Manager may revoke the permit and issue a stop work order, and, if a stop work order is issued, the permittee shall cease work.
- (3) the Manager may reinstate a suspended permit upon permittee's correction of the cause of the suspension.
- (4) the Manager may not reinstate a revoked permit.

(Ord. No. 21320, § 1, 9-28-99)

### **3.4 Chapter 48 – 18 Penalty**

A penalty is hereby established whereby any person who shall violate any provision of this chapter shall be deemed to be guilty of a Class "a" offense. For any second or subsequent offense and upon proof of conviction, said person shall be guilty of a Class "b" offense. Any person who is required by any provision of this chapter or by any other law to obtain a permit prior to engaging in conduct that is regulated by this chapter, and who fails or neglects to obtain such a permit, or who fails to exhibit such a permit upon request by a City official, shall be guilty of a Class "b" offense. Each day on which a violation shall occur or continue to occur shall be deemed a separate offense.

Upon written certification by the Director of the violation of any section of this article, the Municipal Counselor is authorized to petition any court of competent jurisdiction for an injunction to enjoin the continuance of such violation. This remedy shall be cumulative of and to all other enforcement powers granted to the City by the terms of its charter or any ordinance, or by the laws of the State.

If any provision of this article or the application thereof to any person or circumstance shall be held to be invalid, the remainder of this article and the application of such provision to other persons and circumstances shall nevertheless be valid, and the City Council hereby declares that this ordinance would have been enacted without such invalid provision.

(Ord. No. 21320, § 1, 9-28-99; Ord. No. 22776, § 1, 7-19-05)

State law reference—Penalty for ordinance violations, 11 O.S. § 14-111.

### **3.5 Chapter 48 – 19 General Land Disturbing Activity**

All land disturbing activities shall be in compliance with and permitted under this division of this article. Application must be applied for under the "Oklahoma General OPDES Permit for Stormwater Discharges Associated with Construction Activity." If a General OPDES Permit is applied for a copy of a Notice of Intent (NOI), Stormwater Pollution Prevention Plan (SWPPP), and Erosion Control Site Plan (ECSP) must be sent to the Manager of the Stormwater Quality Management Division and a permit fee must be paid.

(Ord. No. 24076, § 2, 6-15-10)

### **3.6 Chapter 48 – 20 Land Disturbing Activity Regulated**

- (a) It shall be unlawful for any person to conduct, or to permit another person to conduct any land disturbing activity upon land without a permit issued under this article. Upon request, any owner of the land and the operator of any land disturbing activity shall provide a copy of the permit and personal identification to the Manager or the Manager's representatives.
- (b) Best Management Practices for Land Disturbing Activities. The minimum standards for controlling erosion and sedimentation from land disturbing activities shall be set forth in the "Best Management Practices Manual," as adopted and amended from time to time by the Director or designee. A copy of same shall be maintained on file in the offices of the Director, the City Engineer, and the Stormwater Quality Manager. A copy of same shall be maintained in the office of the City Clerk and may be viewed and copied in accordance with the provisions of this Code.

(Ord. No. 24076, § 2, 6-15-10)

### **3.7 Chapter 48 – 21 Land Disturbing Permit**

Except as provided in Section 48-16(b) above, no person shall conduct, allow or permit land disturbing activity, whether temporary or permanent, on any premises within The City of Oklahoma City until a land disturbing permit has been issued by the Manager allowing such activity pursuant to the provisions of this article. Such permit shall be available for inspection by the Manager or Manager's representative on the job site at all times during which land disturbing activities are in progress. Such permit shall be required in addition to any building permit or other permit required by the Code for the site.

(Ord. No. 24076, § 2, 6-15-10)

### **3.8 Chapter 48 -22 Permit Application**

- (a) Any application for the issuance of a land disturbing permit under this article shall include the Notice of Intent (NOI), a copy of a Stormwater Pollution Prevention Plan (SWPPP), and an Erosion Control Site Plan (ECSP).
- (b) At any time the Manager determines that the NOI, SWPPP, or ECSP does not comply with the provisions of this article, the Manager shall notify the applicant of all deficiencies within said plan.

(Ord. No. 24076, § 2, 6-15-10)

### 3.9 Chapter 48 – 23 Sediment and Erosion Control

No land disturbing activity shall be conducted within the City except in such manner that:

- (a) stripping of vegetation, re-grading and other development activities shall be conducted so as to minimize erosion. Clearing and grubbing must be held to the minimum necessary for grading and equipment operation. Pre-construction vegetative ground cover shall not be destroyed, removed or disturbed more than 20 calendar days prior to grading or earth moving. Construction must be sequenced to minimize the exposure time of cleared surface area;
- (b) property owners shall be responsible, upon completion of land disturbing activities, for leaving slopes so that they will not erode. Such methods should include re-vegetation, sodding, mulching, rip-rapping, or guniting. Regardless of the method used, the objective will be to leave the site erosion-free and maintenance-free as practicable;
- (c) whenever feasible, natural vegetation shall be retained, protected, and supplemented;
- (d) stabilization measures shall be initiated within 14 days after the construction activity in that portion of the site has temporarily or permanently ceased unless earth disturbing activities on a portion of the site will be resumed within 21 days, temporary stabilization measures do not have to be initiated on that portion of the site. Stabilization measures must be in accordance with standards approved by the Director or designee. Permittee must diligently continue and maintain such stabilization measures until a Notice of Termination has been accepted by the Director or designee;
- (e) a permanent vegetative cover shall be established on disturbed areas not otherwise permanently stabilized;
- (f) to the extent necessary, sediment in runoff water must be trapped by the use of debris basins, sediment basins, silt traps or similar measures until the disturbed area is stabilized;
- (g) neighboring persons and property shall be protected from damage or loss resulting from excessive stormwater runoff, soil erosion or deposition upon private or public property or public streets of water transported silt and debris. Adjacent property owners shall be protected from land devaluation due to exposed bare banks;
- (h) controlled construction entrance/exit shall be maintained in a condition that will prevent tracking or flowing of sediment onto the public right-of-way;
- (i) erosion and sediment control measures must be in place and functional before earth moving operations begin, and must be constructed and maintained throughout the construction period. Temporary measures may be removed at the beginning of the workday, but must be replaced at the end of the workday;
- (j) structural controls shall be designed and maintained as required to prevent pollution. All surface water flowing toward the construction area shall, to the extent practicable, be diverted by using berms, channels, or sediment traps as necessary. Erosion and sediment control measures shall be designed according to the size and slope of disturbed or drainage areas, to detain runoff and trap sediment. Discharges from sediment basins and traps must be through a pipe or lined channel so that the discharge does not cause erosion. Muddy water to be pumped from excavation and work areas must be held in settling basins or treated by filtration prior to its discharge into surface waters;
- (k) inspections will be conducted in accordance with one of the two schedules listed below. Permittee must specify an inspection schedule in the Stormwater Pollution Prevention Plan (SWPPP) which schedule will be either: at least once every seven calendar days, or

at least once every 14 calendar days and within 24 hours of the end of a storm event of 0.5 inches or greater.

- (1) Inspection frequency may be reduced to at least once every month if:
    - (A) the entire site is temporarily stabilized;
    - (B) runoff is unlikely due to winter conditions (eg. Site is covered with snow, ice, or ground is frozen); or
    - (C) construction is occurring during seasonal arid periods in arid areas and semi-arid areas.
  - (2) The permittee shall maintain record of such inspections and repairs for a period of three years after the Notice of Termination (NOT) has been accepted by the Director or designee;
- (l) a specific individual shall be designated to be responsible for erosion and sediment controls on each site;
  - (m) there shall be no distinctly visible floating scum, oil or other matter contained in the stormwater discharge. The stormwater discharge must not cause an objectionable color contrast in the receiving water. The stormwater discharge must result in no materials in concentrations sufficient to be hazardous or otherwise detrimental to humans, livestock, wildlife, plant life, or fish and aquatic life in the receiving stream; and
  - (n) when the land disturbing activity is finished and stable, perennial vegetation has been established on all remaining exposed soil, the permittee shall notify the Manager of these facts and submit a Notice of Termination (NOT) of the permit issued under this section. The Manager shall then provide a final inspection of the site within 20 days after receipt of such notice, and, when advisable, may require additional measures to stabilize the soil and prevent erosion. If such requirements are given by letter, the permittee shall continue to be covered by this provision of this section, until a request for termination of the permit has been accepted by the Manager.
  - (o) There is a re-inspection fee of \$35.00 for each additional trip or inspection. The re-inspection fee shall apply to the following inspections:
    - (1) Should the applicant request an inspection and the applicant, facility, project, and/or property not be ready for said inspection on the date of said inspection then the re-inspection fee shall be due for each subsequent inspection until the applicant, facility, project, or property passes inspection; or
    - (2) Upon an inspection for any other purpose, should the applicant, facility, project, and/or property fail to meet established standards, then the re-inspection fee shall be due for each subsequent inspection until the applicant, facility, project, or property passes inspection; or
    - (3) Upon an inspection within a corrective measure or action is directed by the inspector, then the re-inspection fee shall be due for each subsequent inspection until the correction measure or action and the facility, project, or property passes inspection.

(Ord. No. 24076, § 2, 6-15-10)

# 4

## PERMITTING PROCESS

### **4. Permitting Process**

- 4.1 Obtaining a Permit
- 4.2 Contractor Certification
- 4.3 Terminating Storm Water Construction/Land Disturbing Permit
- 4.4 Re-inspection Fee



## 4. Permitting Process

### 4.1 Obtaining a Permit

A construction Storm Water Discharge Permit is required prior to the start of all land disturbing for the construction of:

- New Utilities
- Industrial, commercial or institutional facilities
- Residential Subdivisions
- Demolition of structures

It is the responsibility of the owner/operator to secure the permit. The following items are needed to obtain a Storm Water Discharge Permit for Construction or Land Disturbing.

1. Notice of Intent (NOI)
  - Sites under one acre of disturbance use OKC-SWQ C-1 form. (see Form 6.1)
  - Sites over one acre of disturbance use ODEQ form 606-002A. (see Form 6.5)
2. Storm Water Pollution Prevention Plan (SWPPP)
  - NOI and SWPPP must be signed by the same person (owner/operator or contractor)
  - Sites under one acre of disturbance can use the City of Oklahoma City's Storm Water Pollution Prevention Plan template. (See Form 6.2)
  - Note: The City of Oklahoma City requires that all projects over one acre follow the ODEQ Template when designing a SWPPP. (See Form 6.7)
3. Erosion Control Site Plan
  - Showing the site to be disturbed, the direction of the flow of the property, all storm water outfalls and all best management practices to be used on the site.
4. A jurisdictional determination from the Oklahoma Corps of Engineers Tulsa District (COE)
  - If the USGS 7.5 Minutes Quadrangle maps indicate that "Waters of the United States" and "Wetlands" exist within this project the applicant is required to submit documentation from the COE showing approval for proposed work.
5. Discharge of a pollutant into any water for which a Total Maximum Daily Load (TMDL) or watershed plan in lieu of a TMDL for that pollutant has been either established or approved by the DEQ or EPA is prohibited unless your discharge is consistent with the TMDL or watershed plan. You must incorporate any limitations, conditions, monitoring and other requirements applicable to your discharges into your SWPPP. If a TMDL, or watershed plan in lieu of a TMDL, is approved for any water body into which you discharge after the date your permit becomes effective, you must incorporate any limitations, conditions and requirements applicable to your discharges into your SWPPP.
6. Permit fees must be submitted to the Oklahoma City Treasurers Office before the permit is issued.

Note: Construction activity that results in land disturbance of equal to or greater than one (1) acre, or less than one (1) if they are a part of a larger common plan of development or sale that totals at least one (1) acre, must also obtain a permit from ODEQ for Storm Water Discharges from Construction Activities. (This means that land disturbance of one (1) acre or more must permit with both the ODEQ and the City of Oklahoma City.)

## 4.2 Contractor Certification

The Contractor Certification Form (See Form 6.4) certifies that the signee (builders or contractors) will assume all physical and monetary responsibility for the best management practices in use on the construction site. The signee should avoid or eliminate any actual or potential adverse effects upon the environment according to the Storm Water Pollution Prevention Plan during all phases of building, construction or delivery activity on any and all project sites under their control.

## 4.3 Terminating Storm Water Construction/Land Disturbing Permit

When the land disturbing activity is finished and stable perennial vegetation has been established on all remaining exposed soil, the Permittee shall notify the Manager of the facts and submit a Notice of Termination (NOT) for the project (See Form 6.3 or 6.6). A Storm Water Construction Technician will inspect the site to determine if the following conditions for the NOT have been met:

- the site must be stabilized with a density of at least 70% per square foot of the original native vegetation, or
- all storm water discharges from the construction activities have been eliminated, or
- if the owner/operator is no longer the owner/operator of the site and a transfer of coverage to a different owner/operator has been received.
- All Storm Water BMPs (such as silt fencing, check dams, etc.) must be removed prior to termination.

If the NOT is approved, a "final" will be issued and the Development Services Department will be notified.

## 4.4 Re-inspection Fee

The re-inspection fee shall apply in the following instances:

- Should the applicant request an inspection and the applicant, facility, project, and/or property not be ready for said inspection on the date of said inspection, then the re-inspection fee shall be due for each subsequent inspection until the applicant, facility, project and/or property passes inspection; or
- Upon an inspection for any other purpose, should the applicant, facility, project, and/or property fail to meet established standards, then the re-inspection fee shall be due for each subsequent inspection until the applicant, facility, project, and/or property passes inspection; or
- Upon an inspection within a corrective measure or action that is directed by the inspector, then the re-inspection fee shall be due for each subsequent inspection until the corrective measure or action and the facility, project, and/or property passes inspection.

# 5

## BMP INSPECTIONS AND MAINTENANCE

- 5. BMP Inspections and Maintenance**
  - 5.1 Inspection and Maintenance Report
  - 5.2 Inspection and Maintenance Record Keeping
  - 5.3 Inspection Frequency/Schedule
  - 5.4 Maintenance Period
  - 5.5 Responsible Person
  - 5.6 Certification Statement Requirement
  - 5.7 Sample Inspection Report

## **5. BMP Inspections and Maintenance**

### **5.1 Inspection and Maintenance Report**

A sample inspection report has been developed as a helpful tool to aid you in completing your site inspections. The inspection report was created consistent with ODEQ Developing Your Stormwater Pollution Prevention Plan. (page 30)

### **5.2 Inspection and Maintenance Record Keeping**

All inspection and maintenance activities should be documented according to the SWPPP requirements and each project should have a maintenance record log. Records should be kept in a log and be made available for review at any time by the Manager or designee. Any deficient BMP elements noted in the inspection should be corrected, repaired or replaced immediately. Major repairs or maintenance work should include the same level of documentation as original installation. All inspection checklists, record logs and site paperwork should be kept for a period of three (3) years from the date of permit termination.

### **5.3 Inspection Frequency/Schedule**

Inspections shall be conducted in accordance with the City Municipal Code Chapter 48-23 (k). Permittees disturbing over one (1) acre must specify an inspection schedule in the Storm Water Pollution Prevention Plan (SWPPP) either at least once every seven (7) calendar days, or at least once (1) every 14 days and within 24-hours of the end of a storm event of 0.5 inches or greater. Unless your construction site discharges into an impaired waterbody with one (1) mile from your site and that impairment is either sediment and/or turbidity, you must include the information of the impairment in your Notice of Intent (NOI) and comply with the requirements in the OKR10 General Permit part 3.5.1B, C and D. Which you must conduct site inspections once every 7 calendar days at a minimum, and within 24 hours of a storm event of 0.5 inches or greater or within 24 hours of a discharge caused by snowmelt.

You must correct any deficiencies in implementation of your SWPPP you find as soon as practicable, but not later than within 14 days of the inspection. You must document in your SWPPP the results of your inspections and the corrective actions you took in response to any deficiencies, or opportunities for improvement, you identify.

### **5.4 Maintenance Period**

The permittee must maintain the site, stabilization controls, and erosion controls in a safe condition and in compliance with City ordinances until final inspection has been completed and Notice of Termination has been accepted by the Director or designee.

### **5.5 Responsible Person**

A designated person or specifically described position will be a duly authorized representative for the purpose of overseeing compliance with environmental requirements of the SWPPP at the construction site. The designee should be authorized to sign any reports and other documents.

## 5.6 Certification Statement Requirement

Any person signing documents shall make the following certification:

"I certify under penalty of law that this document and all attachments were prepared under my direction or supervision in accordance with a system designed to assure that qualified personnel properly gathered and evaluated the information submitted. Based on my inquiry of the person or persons who manage the system, or those persons directly responsible for gathering the information, the information submitted is, to the best of my knowledge and belief, true, accurate and complete. I am aware that there are significant penalties for submitting false information, including the possibility of fine and imprisonment for knowing violations."

## 5.7 Sample Inspection Report

### Instructions

This sample inspection report has been developed as a helpful tool to aid you in completing your site inspections. This sample inspection report was created consistent with ODEQ Developing Your Stormwater Pollution Prevention Plan. You can find both the guide and the sample inspection report at <http://www.deq.state.ok.us/wqdnew/stormwater/constructions/index.html>

This inspection report is provided in Microsoft Word format to allow you to easily customize it for your use and the conditions at your site. You should also customize this form to help you meet the requirements in your construction general permit related to inspections.

### Using the Inspection Report

This inspection report is designed to be customized according to the BMPs and conditions at your site. For ease of use, you should take a copy of your site plan and number all of the stormwater BMPs and areas of your site that will be inspected. A brief description of the BMP or area should then be listed in the site-specific section of the inspection report. For example, specific structural BMPs such as construction site entrances, sediment ponds, or specific areas with silt fence (e.g., silt fence along Main Street; silt fence along slope in NW corner, etc.) should be numbered and listed. You should also number specific non-structural BMPs or areas that will be inspected (such as trash areas, material storage areas, temporary sanitary waste areas, etc).

You can complete the items in the "General Information" section that will remain constant, such as the project name, NPDES tracking number, and inspector (if you only use one inspector). Print out multiple copies of this customized inspection report to use during your inspections.

When conducting the inspection, walk the site by following your site map and numbered BMPs/ areas for inspection. Also note whether the overall site issues have been addressed (customize this list according to the conditions at your site). Note any required corrective actions and the date and responsible person for the correction. (see form 6.8)

# Site Inspection Report

Inspection Date: \_\_\_\_\_

| General Information (OKR10 Part 4.3.13.E)                                                                                                                                                                                                                                                                                              |                         |
|----------------------------------------------------------------------------------------------------------------------------------------------------------------------------------------------------------------------------------------------------------------------------------------------------------------------------------------|-------------------------|
| <b>Name of Project:</b>                                                                                                                                                                                                                                                                                                                | <b>DEQ Permit No.:</b>  |
| <b>Inspector Name:</b>                                                                                                                                                                                                                                                                                                                 | <b>Inspector Title:</b> |
| <b>Inspector's Contact Information:</b>                                                                                                                                                                                                                                                                                                |                         |
| <b>Inspection Frequency:</b>                                                                                                                                                                                                                                                                                                           |                         |
| <b>Standard Frequency:</b> <input type="checkbox"/> Every 7 days and within 24 hours of a 0.50" rain, or discharge from snowmelt<br><input type="checkbox"/> Every 14 days and within 24 hours of a 0.50" rain, or discharge from snowmelt<br><b>Reduced Frequency:</b> <input type="checkbox"/> Once per month (for stabilized areas) |                         |
| <b>Weather at the time of this inspection:</b> _____                                                                                                                                                                                                                                                                                   |                         |
| <b>Was this inspection after a 0.50" storm event?</b> <input type="checkbox"/> Yes <input type="checkbox"/> No, <b>Total rainfall that triggered the inspection</b> (in inches):                                                                                                                                                       |                         |
| <b>Are there any discharges at the time of inspection?</b> <input type="checkbox"/> Yes <input type="checkbox"/> No                                                                                                                                                                                                                    |                         |

List all areas where soil stabilization is required to begin because construction work in that area has permanently or temporarily stopped and all areas where stabilization has been implemented:

| Stabilization of Exposed Soil (OKR10 Part 4.3.13.D) |                      |                                                                                |                                      |
|-----------------------------------------------------|----------------------|--------------------------------------------------------------------------------|--------------------------------------|
| Stabilization Area                                  | Stabilization Method | Have You Initiated Stabilization?                                              | Notes<br>(describe your observation) |
|                                                     |                      | <input type="checkbox"/> Yes <input type="checkbox"/> No If yes, provide date: |                                      |
|                                                     |                      | <input type="checkbox"/> Yes <input type="checkbox"/> No If yes, provide date: |                                      |
|                                                     |                      | <input type="checkbox"/> Yes <input type="checkbox"/> No If yes, provide date: |                                      |
|                                                     |                      | <input type="checkbox"/> Yes <input type="checkbox"/> No If yes, provide date: |                                      |
|                                                     |                      | <input type="checkbox"/> Yes <input type="checkbox"/> No If yes, provide date: |                                      |

*(Notes: For each area where stabilization has been initiated, describe the progress that has been made, and what additional actions are necessary to complete stabilization. Note the effectiveness of stabilization in preventing erosion. If stabilization has been initiated but not completed, make a note of the date it is to be completed. If stabilization has been completed, make a note of the date it was completed. If stabilization has not yet been initiated, make a note of the date it is to be initiated, and the date it is to be completed.)*

Provide a list/description of all structural and non-structural BMPs that your SWP3 indicates will be installed and implemented at your site. You must separately identify the **location** of each control. During Inspection, identify whether they are **installed and operating properly**, or any **corrective action** is necessary. Provide the **date** on which the condition that triggered the need for maintenance or corrective action was first identified. In the notes section you must describe the **specifics about the problem** you observed.

**Condition and Effectiveness of BMP Controls & Pollution Prevention (OKR10 Part 3.3, 4 & 5)**

| No. | BMP Description & Location                         | Is BMP Installed & Operating Properly?                   | Corrective Action (CA) Required?                         | Date on Which Maintenance or CA First Identified? | Notes<br>(describe if you observed any problem) |
|-----|----------------------------------------------------|----------------------------------------------------------|----------------------------------------------------------|---------------------------------------------------|-------------------------------------------------|
| 1.  | Silt Fence/Fiber Rolls/Berm/Wattles<br>Location:   | <input type="checkbox"/> Yes <input type="checkbox"/> No | <input type="checkbox"/> Yes <input type="checkbox"/> No |                                                   |                                                 |
| 2.  | Silt Dikes/Check Dams/Rock Dams<br>Location:       | <input type="checkbox"/> Yes <input type="checkbox"/> No | <input type="checkbox"/> Yes <input type="checkbox"/> No |                                                   |                                                 |
| 3.  | Stabilized Construction Entrance/Exit<br>Location: | <input type="checkbox"/> Yes <input type="checkbox"/> No | <input type="checkbox"/> Yes <input type="checkbox"/> No |                                                   |                                                 |
| 4.  | Inlet Protection on all storm drain<br>Location:   | <input type="checkbox"/> Yes <input type="checkbox"/> No | <input type="checkbox"/> Yes <input type="checkbox"/> No |                                                   |                                                 |
| 5.  | Sand Bag Barrier/Gravel Bag Barrier<br>Location:   | <input type="checkbox"/> Yes <input type="checkbox"/> No | <input type="checkbox"/> Yes <input type="checkbox"/> No |                                                   |                                                 |
| 6.  | Vegetated Swales<br>Location:                      | <input type="checkbox"/> Yes <input type="checkbox"/> No | <input type="checkbox"/> Yes <input type="checkbox"/> No |                                                   |                                                 |
| 7.  | Compost Blankets/Geotextiles/Mats<br>Location:     | <input type="checkbox"/> Yes <input type="checkbox"/> No | <input type="checkbox"/> Yes <input type="checkbox"/> No |                                                   |                                                 |
| 8.  | Vegetative Buffers<br>Location:                    | <input type="checkbox"/> Yes <input type="checkbox"/> No | <input type="checkbox"/> Yes <input type="checkbox"/> No |                                                   |                                                 |
| 9.  | Sediment Trap/ Sediment Basin<br>Location:         | <input type="checkbox"/> Yes <input type="checkbox"/> No | <input type="checkbox"/> Yes <input type="checkbox"/> No |                                                   |                                                 |
| 10. | Concrete Washout Pit<br>Location:                  | <input type="checkbox"/> Yes <input type="checkbox"/> No | <input type="checkbox"/> Yes <input type="checkbox"/> No |                                                   |                                                 |
| 11. | Dust Control/Prevention                            | <input type="checkbox"/> Yes <input type="checkbox"/> No | <input type="checkbox"/> Yes <input type="checkbox"/> No |                                                   |                                                 |
| 12. |                                                    | <input type="checkbox"/> Yes <input type="checkbox"/> No | <input type="checkbox"/> Yes <input type="checkbox"/> No |                                                   |                                                 |
| 13. |                                                    | <input type="checkbox"/> Yes <input type="checkbox"/> No | <input type="checkbox"/> Yes <input type="checkbox"/> No |                                                   |                                                 |
| 14. |                                                    | <input type="checkbox"/> Yes <input type="checkbox"/> No | <input type="checkbox"/> Yes <input type="checkbox"/> No |                                                   |                                                 |
| 15. |                                                    | <input type="checkbox"/> Yes <input type="checkbox"/> No | <input type="checkbox"/> Yes <input type="checkbox"/> No |                                                   |                                                 |
| 16. |                                                    | <input type="checkbox"/> Yes <input type="checkbox"/> No | <input type="checkbox"/> Yes <input type="checkbox"/> No |                                                   |                                                 |

*(Note: The permit differentiates between conditions requiring repairs and maintenance, and those requiring corrective action. The permit requires maintenance in order to keep controls in effective operating condition and requires repairs if controls are not operating as intended. Corrective actions are triggered only for specific, more serious conditions – whether a required stormwater control was never installed, or was installed incorrectly, or not installed in accordance with the requirements of OKR10)*

| Pollution Prevention and Waste Management (OKR10 Part 3.3.3)                                                                                |                                                                         |                  |
|---------------------------------------------------------------------------------------------------------------------------------------------|-------------------------------------------------------------------------|------------------|
| Items of Inspection                                                                                                                         | Response & Reason                                                       | Action(s) Needed |
| Is the site free of floatables, litter, and construction debris?                                                                            | <input type="checkbox"/> Yes <input type="checkbox"/> No If no, reason: |                  |
| Are material storage and handling areas, including fueling areas, free of spills and leaks?                                                 | <input type="checkbox"/> Yes <input type="checkbox"/> No If no, reason: |                  |
| Are spill kits available where spills and leaks are likely to occur?                                                                        | <input type="checkbox"/> Yes <input type="checkbox"/> No If no, reason: |                  |
| Are dumpsters and waste receptacles covered when not in use?                                                                                | <input type="checkbox"/> Yes <input type="checkbox"/> No If no, reason: |                  |
| Has preventative maintenance been conducted on equipment and machinery?                                                                     | <input type="checkbox"/> Yes <input type="checkbox"/> No If no, reason: |                  |
| Are material stockpiles sufficiently contained?                                                                                             | <input type="checkbox"/> Yes <input type="checkbox"/> No If no, reason: |                  |
| Has there been any sediment tracked-out from the site onto the surface of paved street, sidewalks or other paved areas outside of the site? | <input type="checkbox"/> Yes <input type="checkbox"/> No If no, reason: |                  |
| Is the project free from visible erosion and/or sedimentation?                                                                              | <input type="checkbox"/> Yes <input type="checkbox"/> No If no, reason: |                  |

Complete the following section if a discharge is occurring at the time of inspection:

| Description of Discharges (OKR10 Part 4.3.13.D.2.f)                                                                                                                                                                                                          |                                                                                                                                                                                                                                                                                                                                                                                                                                                                                         |
|--------------------------------------------------------------------------------------------------------------------------------------------------------------------------------------------------------------------------------------------------------------|-----------------------------------------------------------------------------------------------------------------------------------------------------------------------------------------------------------------------------------------------------------------------------------------------------------------------------------------------------------------------------------------------------------------------------------------------------------------------------------------|
| Was a stormwater discharge or other discharge occurring from any part of your site at the time of the inspection?<br><input type="checkbox"/> Yes <input type="checkbox"/> No, <b>if yes, provide the following information for each point of discharge:</b> |                                                                                                                                                                                                                                                                                                                                                                                                                                                                                         |
| Specify Discharge Location                                                                                                                                                                                                                                   | Observations (Visual Quality of the Discharge)                                                                                                                                                                                                                                                                                                                                                                                                                                          |
| 1.                                                                                                                                                                                                                                                           | Describe the discharge ( <b>color, odor, floating, settled/suspended solids, foam, &amp; oil sheen</b> ):<br><br>Are there any visible signs of erosion and/or sediment accumulation that can be attributed to your discharge? <input type="checkbox"/> Yes <input type="checkbox"/> No, If yes, describe what you see, specify the location(s) where these conditions were found, and indicate whether modification, maintenance, or corrective action is needed to resolve the issue: |
| 2.                                                                                                                                                                                                                                                           | Describe the discharge ( <b>color, odor, floating, settled/suspended solids, foam, &amp; oil sheen</b> ):<br><br>Are there any visible signs of erosion and/or sediment accumulation that can be attributed to your discharge? <input type="checkbox"/> Yes <input type="checkbox"/> No, If yes, describe what you see, specify the location(s) where these conditions were found, and indicate whether modification, maintenance, or corrective action is needed to resolve the issue: |

**Contractor or Subcontractor Certification and Signature:**

I certify under penalty of law that this document and all attachments were prepared under my direction or supervision in accordance with a system designed to assure that qualified personnel properly gathered and evaluated the information submitted. Based on my inquiry of the person or persons who manage the system, or those persons directly responsible for gathering the information, the information submitted is, to the best of my knowledge and belief, true, accurate, and complete. I am aware that there are significant penalties for submitting false information, including the possibility of fine and imprisonment for knowing violations.

Signature: \_\_\_\_\_

Date: \_\_\_\_\_

Print Name: \_\_\_\_\_

Affiliation: \_\_\_\_\_



# 6 FORMS

## **6. Forms**

- 6.1 OKC-SWQ Form C 1 – Notice of Intent (NOI)
- 6.2 OKC Form – SWPPP for Less Than One (1) Acre of Disturbed Area
- 6.3 OKC-SWQ Form C2 – Notice of Termination (NOT)
- 6.4 Contractor Certification Form
- 6.5 ODEQ Form 606-002A – Notice of Intent (NOI)
- 6.6 ODEQ Form 606-003 – Notice of Termination (NOT)
- 6.7 ODEQ SWPPP Template Form
- 6.8 ODEQ Corrective Action Report
- 6.9 ODEQ Employee Training Report

See Reverse Side for Instructions

**Oklahoma City Storm Water Quality Management Division**

**OKC-SWQ  
FORM  
C 1**



**Notice of Intent (NOI) for Storm Water Discharges Associated  
With CONSTRUCTION ACTIVITY Under the  
OPDES General Permit**

September 26, 2016

SUBMISSION OF THIS NOTICE OF INTENT CONSTITUTES THAT THE PARTY IDENTIFIED IN SECTION I OF THIS FORM INTENDS TO BE AUTHORIZED BY A SWQ PERMIT ISSUED FOR STORM WATER DISCHARGES ASSOCIATED WITH CONSTRUCTION ACTIVITY IN THE CITY OF OKLAHOMA CITY. BECOMING A PERMITTEE OBLIGATES SUCH DISCHARGER TO COMPLY WITH THE TERMS AND CONDITIONS OF THE PERMIT. IN ORDER TO OBTAIN AUTHORIZATION, ALL REQUESTED INFORMATION MUST BE PROVIDED ON THIS FORM. SEE INSTRUCTIONS. **IF YOUR FACILITY OR SITE IS ON INDIAN LAND, FILE YOUR NOI WITH THE EPA.**

**I. FACILITY OWNER/OPERATOR INFORMATION**

Name: \_\_\_\_\_ Phone: \_\_\_\_\_

Street Address: \_\_\_\_\_ E-Mail Add: \_\_\_\_\_

City: \_\_\_\_\_ State: \_\_\_\_\_ Zip Code: \_\_\_\_\_

**II. FACILITY SITE INFORMATION**

Name of the Project: \_\_\_\_\_

Address: \_\_\_\_\_ Phone: \_\_\_\_\_

City: \_\_\_\_\_ State: \_\_\_\_\_ Zip Code: \_\_\_\_\_

Latitude: \_\_\_\_\_ Longitude: \_\_\_\_\_ County: \_\_\_\_\_

Address of Erosion Control/Site Plan/SWP3 for viewing:  Address in I Above  Address in II Above  Other, specify below

Address: \_\_\_\_\_ Phone: \_\_\_\_\_

City: \_\_\_\_\_ State: \_\_\_\_\_ Zip Code: \_\_\_\_\_

Other Operator OPDES Number(s): \_\_\_\_\_ Other Operator NPDES Number(s): \_\_\_\_\_

Receiving Water Body: \_\_\_\_\_

Is the discharge to an impaired water body on the DEQ 303(d) list?  Yes  No

Is there an approved TMDL or watershed plan applicable to this site?  Yes  No

Purpose of the project: \_\_\_\_\_ Estimated area to be disturbed (to nearest acre): \_\_\_\_\_

**Endangered Species**

Based on the instructions provided in Part X and Addendum A of the Permit, is the proposed construction or land disturbing activity within the corridor of any of the listed sensitive waters or watersheds?  Yes  No

If yes, please refer to Part X.B. Step 2.

All Permit eligibility requirements with regard to protection of endangered species through the indicated Section of Part I.B.3e.(2) of the Permit have been complied with. (Check one or more boxes): (a)  (b)  (c)  (d)  (e)  (f)

**III. CERTIFICATION**

I certify under penalty of law that this document and all attachments were prepared under my direction or supervision in accordance with a system designed to assure that qualified personnel properly gather and evaluate the information submitted. Based on my inquiry of the persons who manage the system, or those persons directly responsible for gathering the information, the information submitted is, to the best of my knowledge and belief, true, accurate, and complete. I am aware that there are significant penalties for submitting false information, including the possibility of fine and imprisonment for knowing violations.

I understand that continued coverage under this permit is contingent upon maintaining eligibility as provided for in Part I.B.

Print Name: \_\_\_\_\_ Date: \_\_\_\_\_

Signature: \_\_\_\_\_ Title: \_\_\_\_\_



**Instructions – OKC-SWQ Notice of Intent (NOI)  
For Storm Water Discharges Associated with Construction Activity  
To Be Covered under an OPDES Permit, Form C1**

**Who Must File A Notice of Intent Form**

Under the provisions of the Clean Water Act, as amended, (33 U.S.C..1251 et.seq... the Act). Oklahoma Environmental Code, Title 27A of the Oklahoma Statutes, Section 2-14-101 et.seq. and the rules of OAC 252:002.15, discharge of storm water from construction activities is prohibited without an Oklahoma Pollutant Discharge Elimination System Permit. The operator of a construction site that has such a storm water discharge must submit a NOI to obtain coverage under an OPDES Storm Water General Permit (GP 005A). If you have questions about whether you need a permit under the City of Oklahoma City Storm Water Program, or if you need information, write to the address listed below or telephone the SWQ Division at (405) 297-1774.

**Where to File NOI Form**

NOIs must be sent to the following address:

Public Works Department  
Storm Water Quality Division  
420 W. Main, Suite 360  
Oklahoma City, Oklahoma 73102  
FAX: (405) 297-1770

**Completing The Form**

You must type or print, using upper-case letters, in the appropriate areas only. If you have any questions on this form, call The City of Oklahoma City at (405) 297-1774.

**Section I. Facility Owner/Operator Information**

Provide the legal name, mailing address, and telephone number of the person, firm, public organization, or any other entity that either individually or together meet the following two criteria: (1) have operational control over the site specifications (including the ability to make modifications in specifications); and (2) have the day-to-day operational control of those activities at the site necessary to ensure compliance with plan requirements and permit conditions. Do not use a colloquial name.

**Section II. Facility Site Information**

Enter the Project's official or legal name and complete street address, including city, county, state, ZIP code and phone number. The applicant must also provide the latitude and longitude of the facility in degrees, minutes, and seconds to the nearest 15 seconds (45° 7' 24" = 45.1234 decimal latitude).

Provide the address and phone number where the SWP3 may be viewed, if different from the address previously given. Check the appropriate box.

Are there other OPDES or NPDES permit numbers assigned to this site?

Enter the name of the receiving water body. If no water body exists on site then enter the name of the closest predominant receiving water body. Contact the SWQ Division to obtain more information.

Enter the name of the closest predominant receiving water body. The Oklahoma 303(d) list can be found online at [http://www.deq.state.ok.us/WQDnew/305b\\_303d/index.html](http://www.deq.state.ok.us/WQDnew/305b_303d/index.html) or the DEQ GIS Map and Data Viewer at [http://maps.deq.ok.gov/deq\\_wq/](http://maps.deq.ok.gov/deq_wq/)

Indicate whether your discharge will be consistent with the conditions and requirements of EPA approved or established TMDLs. An approved TMDL report can be found online on the DEQ website at <http://www.deq.state.ok.us/WQDnew/tmdl/index.html>.

Enter the description of the purpose of your project, such as residential subdivision, commercial building, road and bridge, wind farm, etc.

Enter the estimated area to be disturbed including but not limited to: grubbing excavation, grading, and utilities and infrastructure installation. Indicate to the nearest acre.

Indicate if the proposed construction site or land disturbing activity is within the corridor of a listed sensitive water or watershed. Addendum A of the General Permit and associated with the discharges and requirements to be covered by this permit as follows [Section 1.B.3.e(2)].

- a. Storm Water Discharges or related activity is not likely to adversely affect Federal or State listed species or habitat listed in Addendum A.
- b. Construction activity is within a corridor of a Federal Sensitive water or watershed and the SWP3 identifies the precise location and details of the pollution prevention measures to protect endangered species or critical habitat.
- c. Construction activity is within a corridor of a State sensitive water or watershed and the SWP3 identifies the precise location and details of the pollution prevention measures to protect endangered species or critical habitat.
- d. Consultation with the approved USFWS, or ODWC, has concluded that the effects of SWD, results in a no jeopardy opinion or will not adversely affect listed endangered species.
- e. Construction activity is authorized by the USFWS for federally listed sensitive waters or the ODWC for State listed sensitive waters or watersheds, and the possibility of takes was considered. Specific BMP measures are required according to the permit.
- f. SWD and SWD related activity are addressed in another operator's certification of eligibility. The applicant agrees to comply with any measures of control under the other operator's certification.

**Section III. Certification**

Federal Statutes provide for severe penalties for submitting false information on this application form. Federal regulations require this application to signed as follows:

For a corporation: by a responsible corporate officer, which means: (i) president, secretary, treasurer, or vice-president of the corporation in charge of a principal business function, or any other person who performs similar policy or decision making functions, or (ii) the manager of one or more manufacturing, production, or operating facilities employing more than 250 persons or having gross annual sales or expenditures exceeding \$25 million (in second-quarter 1980 dollars), if the authority to sign had been assigned or delegated to the manager in accordance with the corporate procedures;  
For a partnership or sole proprietorship: by a general partner of the proprietor, or;  
For a municipality, state, Federal, or other public facility: by either a principal executive or ranking elected official.

**PLEASE MAKE SURE YOU ACQUIRE A COPY OF THIS PERMIT AND CAREFULLY READ ALL THE TERMS AND CONDITIONS.**



**ONLY FOR USE OF LESS THAN ONE (1) ACRE OF DISTURBED AREA**

**City of Oklahoma City  
Storm Water Quality  
STORM WATER POLLUTION PREVENTION PLAN**



**Section 1: SITE EVALUATION, ASSESSMENT AND PLANNING**

**1.1 Project/Site information:**

Project Name: \_\_\_\_\_

Site Location/Address: \_\_\_\_\_

**1.2 Contact Information/Responsible Parties:**

Company/Organization Name: \_\_\_\_\_

Address: \_\_\_\_\_

Phone/ Fax number: (Phone) \_\_\_\_\_ (Fax) \_\_\_\_\_

Email Address: \_\_\_\_\_

24-Hour Emergency Contact Name/Number: \_\_\_\_\_

**1.3 Nature and Sequence of Construction Activity**

Function of Construction Activity:

- Residential
- Commercial
- Linear
- Demolition
- Road Construction

Estimated Start Date: \_\_\_\_\_ Estimated Completion Date: \_\_\_\_\_

Construction Sequencing/Timing of all Major Events: (Phasing of the project, grading, installation of erosion controls, best management practices and stabilization activities)

The order of activities will be as follows:

1. \_\_\_\_\_
2. \_\_\_\_\_
3. \_\_\_\_\_
4. \_\_\_\_\_
5. \_\_\_\_\_
6. \_\_\_\_\_
7. \_\_\_\_\_

**1.4 Construction Site Estimates:**

Total Project Area: \_\_\_\_\_ Construction Site Area to be disturbed: \_\_\_\_\_

**1.5 Receiving Waters**

If any of the surface waters are listed as impaired by the applicable State or Tribe, provide specified information about pollutants causing the impairment and whether or not a Total Maximum Daily Load (TMDL) has been completed for the surface water. For more information on TMDLs and impaired waters, including a list of TMDL contacts and links by state, visit [www.epa.gov/npdes/stormwater/tmdl](http://www.epa.gov/npdes/stormwater/tmdl).

Deer Creek       Deep Fork Creek       North Canadian River       Canadian River

Is the discharge to an impaired water body on the DEQ 303(d) list?       Yes       No

Is there an approved TMDL or watershed plan applicable to this site?       Yes       No

Is 404 permit required?       Yes       No

**Impaired Waters / TMDLs**

|    | Is this surface water listed as "impaired"?              | If you answered yes, then answer the following: |                                                          |                            |                                        |
|----|----------------------------------------------------------|-------------------------------------------------|----------------------------------------------------------|----------------------------|----------------------------------------|
|    |                                                          | What pollutant(s) are causing the impairment?   | Has a TMDL been completed?                               | Title of the TMDL document | Pollutant(s) for which there is a TMDL |
| 1. | <input type="checkbox"/> YES <input type="checkbox"/> NO |                                                 | <input type="checkbox"/> YES <input type="checkbox"/> NO |                            |                                        |
| 2. | <input type="checkbox"/> YES <input type="checkbox"/> NO |                                                 | <input type="checkbox"/> YES <input type="checkbox"/> NO |                            |                                        |
| 3. | <input type="checkbox"/> YES <input type="checkbox"/> NO |                                                 | <input type="checkbox"/> YES <input type="checkbox"/> NO |                            |                                        |
| 4. | <input type="checkbox"/> YES <input type="checkbox"/> NO |                                                 | <input type="checkbox"/> YES <input type="checkbox"/> NO |                            |                                        |
| 5. | <input type="checkbox"/> YES <input type="checkbox"/> NO |                                                 | <input type="checkbox"/> YES <input type="checkbox"/> NO |                            |                                        |
| 6. | <input type="checkbox"/> YES <input type="checkbox"/> NO |                                                 | <input type="checkbox"/> YES <input type="checkbox"/> NO |                            |                                        |

**1.6 Potential Sources of Pollution**

Potential sources of sediment to storm water and potential pollutants and sources, other than sediment to storm water runoff: (check boxes)

- Clearing and grubbing operations       Vehicle tracking       Topsoil stripping and stockpiling
- Landscaping operations       Fueling activities       Minor equipment maintenance       Cleaning solvents
- Concrete Washout Area       Pesticide/Fertilizer       Plaster       Asphalt       Concrete       Paints
- Glue, adhesives       Curing compounds       Wood preservatives       Hydraulic oil/fluids       Gasoline
- Diesel fuel       Kerosene       Antifreeze/Coolant       Sanitary toilets       Others \_\_\_\_\_

**1.7 Site Maps**

Site maps will be modified if control measures outlined within do not meet the goals of the plan, or if directed by the State or City officials. The site plans must be modified as phases of the project are completed.

**Section 2: EROSION AND SEDIMENT CONTROL BMP'S**

**2.1 Establish Perimeter Controls, Sediment Barriers, and Erosion Controls**

The following Best Management Practices (BMPs) will be implemented as sediment and erosion controls (check boxes)

- Vegetative Swale       Hydro mulching       Dust Control       Geotextile Erosion Control Blanket
- Storm Drain Inlets       Silt Fence       Fiber rolls       Sediment Trap       Sediment Basin
- Stabilized Construction Entrance/Exit       Street Sweeping       Sod       Seeding
- Other BMPs \_\_\_\_\_

**2.2 Establish Stabilized Construction Exit**

The temporary stabilized exit(s) will be installed before construction begins on the site. The Oklahoma City Standard for installation of temporary construction exits will be followed: **20' X 50', with filter fabric underneath, 2"-3" course aggregate, minimum 6" in depth.**

**2.3 Installation Schedule**

- Erosion and sediment control BMPs will be installed before grading activities begin.
- Portions of the site where construction activities will temporarily cease for more than 14 days will be stabilized with mulch or geotextile erosion control blankets.
- Storm drain inlets will be protected from sediment.
- Street sweeping will occur weekly or as needed.
- Dust control will be implemented as needed once site grading has been initiated and during windy conditions.

**2.4 Maintenance and Inspection**

- Each BMP will be inspected weekly and immediately after storm events for erosion and structural failures and accumulation of debris and sediment.
- Silt fences will be inspected weekly and immediately after storm events to ensure it is intact and that there are no gaps where the fence meets the ground or tears along the length of the fence and repaired or replaced immediately. Accumulated sediment will be removed from the fence base if it reaches one-third the height of the silt fence. The anticipated life span of the silt fence is 6 months and will likely need to be replaced after this period.
- The exit(s) will be inspected weekly and after storm events or heavy use and shall be maintained in a condition that will prevent tracking of sediment onto public rights-of-way.

**2.5 Responsible Staff**

A designated person or specifically described position will be a duly authorized representative for the purpose of overseeing compliance with environmental requirements of this Storm Water Pollution Prevention Plan at the construction site. The designee is authorized to sign any reports and other documents required by this plan.

**Section 3: GOOD HOUSEKEEPING BMP's**

**3.1 Establish Material Handling and Waste Management BMPs**

- Dumpsters will have a secure watertight lid, be placed away from stormwater conveyances and drains, and meet all federal, state, and municipal regulations. Only trash and construction debris from the site will be deposited in the dumpster. No construction materials will be buried on site.
- Hazardous waste materials will be stored in appropriate and clearly marked containers and segregated from other non-waste materials
- The portable toilets will be located away from concentrated flow paths and traffic flow and will have collection pans underneath as secondary containment.
- Wood pallets, cardboard boxes, and other recyclable construction scraps will be disposed of in a designated dumpster for recycling. The dumpster will have a secure watertight lid, be placed away from stormwater conveyances and drains and meet all local and state solid-waste management regulations.
- Paint Containers will be tightly sealed when not in use, and excess paint shall be disposed of according to Oklahoma requirements and manufacturer's recommendations.
- Minimum amounts of fertilizer, as recommended by the manufacturer, will be used. Upon application the fertilizer will be worked into the soil to limit exposure to storm water. Contents of partially used bags will be transferred to a sealable plastic bin, and then stored in a covered area.

The following BMP measures will be used to handle trash disposal, sanitary waste, recycling, and proper material handling. (Check boxes)

- Trash Dumpsters     Hazardous Waste Containment     Portable Toilets     Recycling Bins/Dumpsters
- Other BMPs \_\_\_\_\_

**3.2 Designated Washout Areas**

- A designated temporary, above-grade concrete washout area will be constructed as detailed on the site map, with sufficient quantity and volume to contain all liquid and concrete waste generated by washout operations. The washout area will be lined with plastic sheeting at least 10 mils thick and free of any holes or tears. Signs will be posted marking the location of the washout area to ensure that concrete equipment operators use the proper facility. When the temporary washout area is no longer needed for the construction project, the hardened concrete and materials used to construct the area will be removed and disposed of and the area will be stabilized.

The types of washout discharges expected for this project site. (check boxes)

- Concrete     Paint     Stucco     Tire Wash     Other \_\_\_\_\_

**3.3 Establish Proper Equipment/Vehicle Fueling and Maintenance Practices**

- Several types of vehicles and equipment will be used on-site throughout the project, including graders, scrapers, excavators, loaders, paving equipment, rollers, trucks and trailers, backhoes, and forklifts. All major equipment/vehicle fueling and maintenance will be performed off-site. When vehicle fueling must occur on-site, the fueling activity will occur in the staging area. Absorbent, spill-cleanup materials and spill kits will be available at the combined staging and materials storage area.
- Containers used for Petroleum storage shall be tightly sealed and clearly labeled. Onsite gas tanks will be protected with a lined dirt berm or other appropriate BMP measure completely surrounding the tank in case of a leak or spill

The following types of BMPs will be implemented that will control pollutants to storm water from equipment/vehicle fueling and maintenance practices for the project. (Check boxes)

- Secondary containment    Drip Pans    Spill Kits    Other BMPs \_\_\_\_\_

**3.4 Non-Storm Water Discharge Management**

The following non-storm water discharge may be present during construction.

- Water used to wash vehicles where detergents are not used    Water to control dust    Potable water including uncontaminated water line flushing    Routine external building wash down that does not use detergents    Pavement wash waters where spills or leaks of toxic or hazardous materials have not occurred and where detergents are not used
- Uncontaminated air conditioning or compressor condensate    Uncontaminated ground water or spring water
- Foundation or footing drains where flows are not contaminated with process materials such as solvents
- Uncontaminated excavation dewatering    Landscape irrigation

**3.5 Installation Schedule**

- Trash dumpster will be installed once the materials storage area has been established.
- The portable toilets will be brought to the site once the staging area has been established.
- Designated recycling dumpsters will be installed once the combined staging area has been established.
- The washout area will be constructed before concrete pours occur at the site.
- BMPs implemented for equipment and vehicle maintenance and fueling activities will begin at the start of the project.

**3.6 Maintenance and Inspection**

- The dumpsters will be inspected weekly and immediately after storm events.
- The portable toilets will be inspected weekly for evidence of leaking holding tanks. Toilets with leaking holding tanks will be removed from the site and replaced with new portable toilets.
- The recycling dumpster will be inspected weekly and immediately after storm events.
- The washout areas will be inspected daily to ensure that all concrete washing is being discharged into the washout area, no leaks or tears are present, and to identify when concrete wastes need to be removed. The washout areas will be cleaned out once the area is filled to 75 percent of the holding capacity. Once the area's holding capacity has been reached, the concrete wastes will be allowed to harden; the concrete will be broken up and removed. The plastic sheeting will be replaced if tears occur during removal of concrete wastes from the washout area.
- The equipment/vehicle storage area and fuel tanks will be inspected weekly and after storm events. Vehicles and equipment will be inspected on each day of use. Leaks will be repaired immediately, or the problem vehicle(s) or equipment will be removed from the project site.

**3.7 Responsible Staff**

Hazardous waste materials will be stored in appropriate and clearly marked containers and segregated from other non-waste materials. Additionally, all hazardous waste materials will be disposed of in accordance with federal, state, and municipal regulations. Hazardous waste materials will not be disposed of into the on-site dumpsters.

**Section 4: POST-CONSTRUCTION BMPs**

4.1 The following post construction stormwater management measures will be installed during the construction process to control pollutants in stormwater discharges after construction operations have been completed.

- Biofilters
- Detention/retention devices
- Earth dikes, drainage swells, and lined ditches
- Infiltration basins
- Rain gardens
- Porous pavement
- Other proprietary permanent structural BMPs
- Outlet protection/velocity dissipation devices
- Slope protection
- Vegetated strips and /or swales

**Section 5: INSPECTIONS**

**5.1 Inspections**

Inspection of the site will be performed once every 7 days and within 24 hours of the end of a storm event of one-half inch or greater. The inspections will verify that all BMPs are implemented, maintained, and effectively minimizing erosion and preventing storm water contamination from construction materials. The permittee shall maintain records of such inspections and repairs for a period of at least 3 years after the permit is terminated.

**5.2 Delegation of Authority**

I, \_\_\_\_\_ (owners name), hereby designate the person or specifically described position below to be duly authorized representative for the purpose of overseeing compliance with environmental requirements, including the Construction General Permit at the \_\_\_\_\_ construction site. The designee is authorized to sign any reports, storm water pollution prevention plans and all other documents required by the permit.

\_\_\_\_\_ (Name of person or position)

\_\_\_\_\_ (Company)

\_\_\_\_\_ (Address)

\_\_\_\_\_ (City, State, Zip)

\_\_\_\_\_ (Phone)

**5.3 Corrective Action Log**

This log will describe repairs, replacements and maintenance of BMP's undertaken as a result of the inspections and maintenance procedures described above.

**Section 6: RECORDKEEPING AND TRAINING**

**6.1 Recordkeeping**

The following is a list of records that will be kept and made available for inspectors to review at the project site. The SWPPP, erosion control site plan, maps, dates of grading, construction activity and stabilization, a signed NOI form, date(s) when major grading activities occur, date(s) when construction activities temporarily or permanently cease on a portion of the site and date(s) when an area is either temporarily or permanently stabilized. Records will be maintained for a period of at least three (3) years after the permit is terminated.

**6.2 Log Changes to the SWPPP**

Log any additional new BMP's, replacement of failed BMP's, significant changes in the activities or their timing on the project, changes in personnel, changes in inspection and maintenance procedures and updates on the SWPPP and the erosion control site maps

**6.3 Training**

All training conducted for staff and subcontractors with specific storm water responsibilities (e.g., installing, inspecting and maintaining BMP's, include date of training, names of attendees, subjects covered and length of training) will documented in a training log.



**Section 7: FINAL STABILIZATION**

- 7.1 When major construction activities are complete on part of the site and final stabilization efforts for that portion of the site have been documented, many permits will allow the applicant to discontinue inspection activities on the area. The permittee can amend or add to this section as areas of the project are finally stabilized. The permittee will update the site plan to indicate areas that have achieved final stabilization.
- 7.2 A Notice of Termination (NOT) will be filed when the site has been fully stabilized (e.g., a uniform perennial vegetative cover with a density of at least 70% of the native background cover has been established for all unpaved area) and all storm water discharges from construction activity are eliminated, or the operator is no longer the operator of the site as long as the new operator has filed the Notice of Intent (NOI).

**Section 8: CERTIFICATION AND NOTIFICATION**

- 8.1 **Certification of Compliance**  
All provisions of the Storm Water Pollution Prevention Plan, and State and City requirements will be complied with throughout the duration of this construction project. **The SWP3 may be modified if control measures outlined within do not meet the goals of the plan, or if directed by State or City officials, to remain in compliance with regulations.**
- 8.2 **Contractors Certification**  
Contractors, subcontractors, builders, regular suppliers, or any person involved with the construction activities are required to be familiar with and adhere to the Notice of Intent (NOI), the Storm Water Pollution Prevention Plan (SWP3), and Best Management Practices (BMP's). Contractor Certifications allow the Permittee(s) to specify the BMPs each party will be responsible to implement and/or maintain on the project (including replacement or repair of controls affected by their activities). Signing the Contractor Certification will include the party(ies) as being responsible for the portion(s) of this SWP3 that pertain to their activities on the site, thereby extending the responsibility of compliance to include all parties involved in the construction project. Contractor Certifications should be signed prior to the start of any work covered in this plan. Although Contractor Certifications are recommended, they are not required.
- 8.3 **Accessibility of Documents**  
Copies of the Storm Water Pollution Prevention Plan, the Notice of Intent, Operator's weekly inspection reports, and an erosion controls site plan will be onsite and available to City officials upon request.
- 8.4 **Pollution Prevention Plan Certification**  
*"I certify under penalty of law that this document and all attachments were prepared under my direction or supervision in accordance with a system designed to assure that qualified personnel properly gathered and evaluated the information submitted. Based on my inquiry of the person or persons who manage this system, or those persons directly responsible for gathering the information, the information submitted is, to the best of my knowledge and belief, true, accurate, and complete. I am aware that there are significant penalties for submitting false information, including the possibility of fine and imprisonment of knowing violations."*

**PRINT NAME:** \_\_\_\_\_

**SIGNATURE:** \_\_\_\_\_

**PHONE NUMBER:** \_\_\_\_\_

**EMAIL ADDRESS:** \_\_\_\_\_

**DATE:** \_\_\_\_\_

**OKC-SWQ  
FORM  
C 2**  
September 8,  
2016



**City of Oklahoma City  
Notice of TERMINATION (NOT) for Storm Water Discharges  
Associated with INDUSTRIAL OR CONSTRUCTION ACTIVITY  
Under an OPDES General Permit**

Submission of this Notice of Termination constitutes notice of the party identified in Section I of this form is no longer authorized to discharge storm water associated with industrial or construction activities under the OPDES program.

**ALL REQUESTED INFORMATION MUST BE PROVIDED ON THIS FORM. SEE INSTRUCTIONS.**

**Storm Water Permit Number:** \_\_\_\_\_

Check here if you are no longer the operator of the facility:

**Building Permit Number:** \_\_\_\_\_

**II. FACILITY OPERATOR INFORMATION**

Name: \_\_\_\_\_ Phone: \_\_\_\_\_

Address: \_\_\_\_\_

City: \_\_\_\_\_ County: \_\_\_\_\_ Zip Code: \_\_\_\_\_

**III. FACILITY/SITE LOCATION**

Name of Project: \_\_\_\_\_

Address: \_\_\_\_\_

City: \_\_\_\_\_ County: \_\_\_\_\_ Zip Code: \_\_\_\_\_

**IV. New Facility/Site Information:**

If you are no longer the operator of the facility/site, provide the following information pertaining to the new operator at the facility/site:

Name: \_\_\_\_\_

Address: \_\_\_\_\_

City: \_\_\_\_\_ State: \_\_\_\_\_ Zip Code: \_\_\_\_\_

**V. CERTIFICATION**

I certify under penalty of law that all storm water discharges associated with industrial/construction activity from the identified facility that are authorized by a SWQ/OPDES general permit have been eliminated or that I am no longer the operator of the facility or the construction site. I understand that by submitting this notice of termination, I am no longer authorized to discharge storm water associated with industrial or construction activity under this general permit, and that discharging pollutants in storm water associated with industrial or construction activity to waters of the state is unlawful under SWQ/OPDES where the discharge is not authorized by an SWQ/OPDES permit. I also understand that the submittal of this notice of termination does not release an operator from liability for any violations of this permit or SWQ/OPDES rules and procedures.

Print Name: \_\_\_\_\_ Date: \_\_\_\_\_

Signature: \_\_\_\_\_ Title: \_\_\_\_\_



## Instructions -- OKC-SWQ Notice of TERMINATION (NOT) for Form C 2 For Storm Water Discharges Associated with Industrial or Construction Activity

### When To File NOT Form:

Permittees who are presently covered under an issued NPDES or SWQ/OPDES general permit for storm water discharges associated with industrial activity may submit a **Notice of Termination (NOT)** form when their facilities no longer have any storm water discharges associated with industrial activity as defined in the storm water regulations at 40 CFR 122.26(b)(14), or when they are no longer the operator of the facilities. For a construction site, when the site has been finally stabilized (i.e., a uniform perennial vegetative cover with a density of at least 70% of the native background cover has been established for all unpaved areas and areas not covered by permanent structures or where permanent structures or where equivalent permanent stabilization measures such as riprap or gabions have been used), and all storm water discharges from construction activities that are authorized by general permit (GP-005A) are eliminated, or they are no longer the operator of the facility, a NOT must be submitted that is signed in accordance with part VI.G of the general permit. If you need assistance contact the Storm Water Quality office of The City of Oklahoma City at 297-1774.

### Section I: Permit Information:

Enter the existing NPDES or SWQ/OPDES General Storm Water Permit number assigned to the facility or site identified in Section II.

### Section II. Facility Operator Information:

Give the legal name of the person, firm, public organization or any other entity that operates the facility or site described in this application. The name of the operator may or may not be the same name as the facility. The operator of the facility is the legal entity which controls the facility's operation, rather than the plant or site manager.

### Section III: Facility/Site Location Information:

Enter the facility's or site's official or legal name and complete address, including city, state, and ZIP code. If the facility lacks a street address, indicate the latitude and longitude of the facility to the nearest 15 seconds, or the quarter, section, township, and range of the approximate center of the site.

### Section IV: Certification

The NOT form must be signed by a responsible party as follows:

For a Corporation: by a responsible officer, which means: (1) president, secretary, treasurer, or vice president of the corporation in charge of a principal business function; (2) the manager of one or more manufacturing, production, or operating facilities employing 250 persons or having gross annual sales or expenditures exceeding \$25 million (in second-quarter 1980 dollars) if authority to sign documents has been assigned or delegated to the manager in accordance with corporate procedures.

For a partnership or sole proprietorship: by a general partner or the proprietor.

For a municipality, state, Federal, or other public facility: by either principal executive officer or ranking elected official.

### Where to File a NOT form:

NOT's must be sent to the following address:

Public Works Department  
Storm Water Quality Division  
420 W. Main, Suite 360  
Oklahoma City, Oklahoma 73102  
Fax (405) 297-1770

## Contractors Certification Form

**CERTIFICATION BY BUILDERS OR CONTRACTORS THAT THEY ASSUME ALL PHYSICAL AND MONETARY RESPONSIBILITY TO AVOID OR ELIMINATE ANY ACTUAL OR POTENTIAL ADVERSE EFFECTS UPON THE ENVIRONMENT ACCORDING TO THE STORM WATER POLLUTION PREVENTION PLAN (SWPPP), DURING ALL PHASES OF BUILDING, CONSTRUCTION, OR DELIVERY ACTIVITY ON ANY, AND ALL, HOME SITES UNDER THEIR CONTROL**

1. Builder or contractor company name: \_\_\_\_\_  
 2. Address of home sites acquired: \_\_\_\_\_  
 \_\_\_\_\_  
 \_\_\_\_\_  
 \_\_\_\_\_

(For additional addresses, attach list to this form)

3. Builders and contractors must be thoroughly familiar with the original Notice of Intent (NOI) filed by (Developer Name) \_\_\_\_\_ with the Oklahoma Department of Environmental Quality (DEQ). Builders and contractors must also be thoroughly familiar with, and adhere to, the Storm Water Pollution Prevention Plan (SWPPP) and the Best Management Practices (BMP) on file at the following location (Name of Location) \_\_\_\_\_. The builder or contractor is certifying below that they assume all physical and monetary responsibility to avoid or eliminate any actual or potential adverse effects upon the environment pertaining to the property listed in Item 2 above.

4. Builders or contractors must certify under item (e) below. Item (e) certifies that the applicant’s activity is considered as part of a larger, more comprehensive site-specific assessment of impacts on endangered and threatened species by the owner or the operator of the site when it developed a SWPPP. Furthermore, the owner or operator certified eligibility under item (a), (b), (c), or (d) of the permit (e.g., owner was able to certify no adverse impacts for the project as a whole under item (a), so builder or contractor can certify under item (e)).

### Certification

I certify under penalty of law that I have read and understand the Part I.B. eligibility requirements for coverage under the general permit for storm water discharges from construction activities, including those requirements published in the DEQ General Permit GP-005 and the Storm Water Pollution Prevention Plan (SWPPP) and the Best Management Practices (BMP) described in Item 3 above.

I further certify that I have followed the procedures found in Addendum A to protect listed endangered and threatened species and designated critical habitat and that the discharges covered under this permit and BMP to control storm water run-off meet one or more of the eligibility requirements of Part I.B.3.e.(1) of this permit.

Check the box(es) corresponding to the part of Part I.B.3.e(1) under which you claim compliance with the eligibility requirements of this permit.

- (a)       (b)       (c)       (d)       (e)

I understand that continued coverage under this permit is contingent upon maintaining eligibility as provided for in Part I.B.

I certify under penalty of law that this document and all attachments were prepared under my direction or supervision in accordance with a system design to assure that qualified personnel properly gather and evaluate the information submitted. Based on my inquiry of the person or persons who manage this system, or those persons directly responsible for gathering the information, the information submitted is, to the best of my knowledge and belief, true, accurate, and complete. I am aware that there are significant penalties for submitting false information, including the possibility of fine and imprisonment for knowing violations.

Print Name: \_\_\_\_\_ Date: \_\_\_\_\_

Signature: \_\_\_\_\_

|                                               |                                                                                   |                                                                                                                                                                                                          |
|-----------------------------------------------|-----------------------------------------------------------------------------------|----------------------------------------------------------------------------------------------------------------------------------------------------------------------------------------------------------|
| <b>DEQ Form<br/>606-002A<br/>Oct 18, 2017</b> |  | <b>Oklahoma Department of Environmental Quality<br/>Notice of Intent (NOI)<br/>for Stormwater Discharges Associated with Construction Activity under<br/>the OPDES Construction General Permit OKR10</b> |
|-----------------------------------------------|-----------------------------------------------------------------------------------|----------------------------------------------------------------------------------------------------------------------------------------------------------------------------------------------------------|

Submission of this NOI constitutes notice that the party identified in Section I of this form intends to be authorized by DEQ for stormwater discharges associated with construction activity on land disturbance of equal to or greater than 1 or more acres, or less than 1 acre of total land area that is part of a larger common plan of development or sale in the State of Oklahoma. Becoming a permittee obligates such discharger to comply with the terms and conditions of the OKR10 permit. To obtain an authorization from DEQ, this form must be complete with all the pertinent information.  
**All associated fees must be submitted with this NOI. See instructions for completing the NOI on pages 3 and 4 of this form.**

NEW APPLICATION,  MODIFICATION or  RENEWAL of current permit, enter the authorization number: **OKR10**

**I. Operator Information**

Operator Name: \_\_\_\_\_ Phone: \_\_\_\_\_

Mailing Address: \_\_\_\_\_

City: \_\_\_\_\_ State: \_\_\_\_\_ Zip Code: \_\_\_\_\_

Operator's Point of Contact : \_\_\_\_\_ Title: \_\_\_\_\_

Phone: \_\_\_\_\_ E-mail: \_\_\_\_\_

**II. Site/Project Information**

Site/Project Name: \_\_\_\_\_ Phone: \_\_\_\_\_

Site/Project Address: \_\_\_\_\_

City: \_\_\_\_\_ County: \_\_\_\_\_ State: \_\_\_\_\_ Zip Code: \_\_\_\_\_

Site/Project's Point of Contact : \_\_\_\_\_ Title: \_\_\_\_\_

Phone: \_\_\_\_\_ E-mail: \_\_\_\_\_

Site/Project's purpose:  Road/Bridge  Wind Farm  Residential Subdivision  Commercial Building  Others

Latitude: \_\_\_\_\_ Longitude: \_\_\_\_\_ at the center of the Site/Project or starting and ending points for Linear Project

Latitude: \_\_\_\_\_ Longitude: \_\_\_\_\_

Estimated construction start date: \_\_\_\_\_ Estimated construction end date: \_\_\_\_\_

Total area of the construction site: \_\_\_\_\_ (acres) Estimated area to be disturbed: \_\_\_\_\_ (acres)

Current total impervious area: \_\_\_\_\_ (acres) Post-construction total impervious area: \_\_\_\_\_ (acres)

Post-construction runoff coefficient of the site: \_\_\_\_\_ Soil and fill material description: \_\_\_\_\_

Is this site part of the common plan of development or sales?  Yes  No

**Endangered Species Eligibility**

- a.  My site/project is not located within any of the corridors of Federal and State identified Aquatic Resources of Concern (ARC);
- b.  My site/project is located within a corridor of Federal and State identified ARC and I agree to implement the control measures specified in Step 2 of Part 10.2 of the OKR10 permit;
- c.  If one of eligibility criteria cannot be met, I may use Addendum H for equivalent sediment controls or contact DEQ at (405)702-8100 for further assistance;
- d.  I am required to have an Endangered Species Act Section 7 consultation process and
- e.  I am relying on another permittee's certification of eligibility and agree to comply with the conditions of that certification.

### III. Site/Project Discharge Information

Does the facility discharge stormwater into a MS4?  Yes  No, If yes, name of the MS4 Operator: \_\_\_\_\_

#### Receiving Water Information (note: use additional sheet of paper if necessary)

| Name of the Receiving Waterbody | Is this waterbody impaired?<br>If so, what are its impairments? | Is there a TMDL for that impairment?                     |
|---------------------------------|-----------------------------------------------------------------|----------------------------------------------------------|
|                                 | <input type="checkbox"/> Yes <input type="checkbox"/> No        | <input type="checkbox"/> Yes <input type="checkbox"/> No |
|                                 | <input type="checkbox"/> Yes <input type="checkbox"/> No        | <input type="checkbox"/> Yes <input type="checkbox"/> No |
|                                 | <input type="checkbox"/> Yes <input type="checkbox"/> No        | <input type="checkbox"/> Yes <input type="checkbox"/> No |
|                                 | <input type="checkbox"/> Yes <input type="checkbox"/> No        | <input type="checkbox"/> Yes <input type="checkbox"/> No |

### IV. Stormwater Pollution Prevention Plan (SWP3) Information

Has the SWP3 been prepared and available on site?  Yes  No

Is the operator registered for construction activities with the Secretary of State of Oklahoma?  Yes  No

Proposed Best Management Practices to control pollution in the stormwater discharges, check all that apply:

- |                                                    |                                              |                                                      |                                           |
|----------------------------------------------------|----------------------------------------------|------------------------------------------------------|-------------------------------------------|
| <input type="checkbox"/> Construction phased       | <input type="checkbox"/> Sediment basin/trap | <input type="checkbox"/> Mulching/seeding/sodding    | <input type="checkbox"/> Vegetated buffer |
| <input type="checkbox"/> Vehicle/concrete wash-out | <input type="checkbox"/> Site inspection     | <input type="checkbox"/> Diversion dikes             | <input type="checkbox"/> Inlet protection |
| <input type="checkbox"/> Construction entrances    | <input type="checkbox"/> Silt fence          | <input type="checkbox"/> Waste management            | <input type="checkbox"/> Stream crossings |
| <input type="checkbox"/> Spill prevention/cleanup  | <input type="checkbox"/> Employee training   | <input type="checkbox"/> Compost blanket/geotextiles | <input type="checkbox"/> Check dams       |
| <input type="checkbox"/> Construction sequencing   | <input type="checkbox"/> Riprap              | <input type="checkbox"/> Gradient terraces           | <input type="checkbox"/> Silt dikes       |

Other BMPs: \_\_\_\_\_

Post-construction Best Management Practices for construction activities, Check all that apply:

- |                                                     |                                        |                                                     |                                                 |
|-----------------------------------------------------|----------------------------------------|-----------------------------------------------------|-------------------------------------------------|
| <input type="checkbox"/> Narrow street/turnaround   | <input type="checkbox"/> Wet/dry pond  | <input type="checkbox"/> Protected natural features | <input type="checkbox"/> Vegetated filter trips |
| <input type="checkbox"/> Eliminated curbs & gutters | <input type="checkbox"/> Wetland       | <input type="checkbox"/> Infiltration basin/trench  | <input type="checkbox"/> Porous pavement        |
| <input type="checkbox"/> Bio-retention/rain gardens | <input type="checkbox"/> Riparian      | <input type="checkbox"/> Redevelopment/retrofit     | <input type="checkbox"/> Grassed swales         |
| <input type="checkbox"/> Low impact development     | <input type="checkbox"/> Green designs | <input type="checkbox"/> Conservation easements     | <input type="checkbox"/> Retrofit               |

Other BMPs: \_\_\_\_\_

### V. Certification

*I certify under penalty of law that this document and all attachments were prepared under my direction or supervision in accordance with a system designed to assure that qualified personnel properly gathered and evaluated the information submitted. Based on my inquiry of the person or persons who manage the system, or those persons directly responsible for gathering the information, the information submitted is, to the best of my knowledge and belief, true, accurate, and complete. I have no personal knowledge that the information submitted is other than true, accurate, and complete. I am aware that there are significant penalties for submitting false information, including the possibility of fine and imprisonment for knowing violations.*

Print Name: \_\_\_\_\_ Title: \_\_\_\_\_

Signature: \_\_\_\_\_ Date: \_\_\_\_\_

For DEQ use only: Assigned Authorization Number: OKR10 \_\_\_\_\_



## Instructions for Completing NOI Form 606-002A for Stormwater Discharges Associated with Construction Activity on Sites of One or more acres under the OPDES Construction General Permit OKR10

### Who Must File an NOI Form

Under Section 402(p) of the Clean Water Act and regulation at 40 CFR § 122.26, adopted and incorporated by reference in Oklahoma Administrative Code (OAC) 252:606-1-3(b)(3)(L), stormwater discharges associated with construction activities are prohibited to waters of Oklahoma State unless authorized under an Oklahoma Pollutant Discharge Elimination System (OPDES) permit from Oklahoma Department of Environmental Quality (DEQ). Operators of construction sites where one or more acres are disturbed, smaller sites that are part of a larger common plan of development or sale where there is a cumulative disturbance of at least one acre must obtain coverage under the OPDES Construction General Permit (CGP) OKR10 by submitting a completed NOI to DEQ. If you have questions regarding permit coverage under the Stormwater Program, you may call the Stormwater Unit of Environmental Complaints and Local Services (ECLS) of DEQ at (405) 702-6100 or email to [ecls-stormwaterpermitting@deq.ok.gov](mailto:ecls-stormwaterpermitting@deq.ok.gov).

### Completing the NOI Form

To complete an NOI form, type or print in all the appropriate places of the form. Check the appropriate box whether you are filing for a new application or modification or renewal of your current permit. Enter your current authorization number, if you are applying for permit modification or renewal.

### Section I. Operator Information

Provide the legal name, mailing address and telephone number of the company/firm, public organization, or any other entity that either individually or together meets the following two criteria: (1) have operational control over construction plans and specifications, including that the ability to make modifications to those plans and specifications (e.g., in most cases this is the owner of the site); and/or (2) have the day-to-day operational control of those activities at the site necessary to ensure compliance with Stormwater Pollution Prevention Plan (SWP3) and/or other permit conditions (e.g., they are authorized to direct worker at a site to carry out activities required by the permit; in most cases this the general contractor of the project).

Also enter the name, title, phone number, and email address for the operator's point of contact.

### Section II. Site/Project Information

Provide the site/project's official or legal name, phone number and street address or general location information (e.g., Intersection of State Highways 61 and 34). Also provide the name, title, phone number, and email address for the site/project's point of contact.

Indicate the purpose of the project (i.e., residential subdivision, commercial building, road and/or bridges, wind farm, etc.).

Provide Latitude and Longitude of the construction project or site (at the center of the site). Latitude and Longitude can be obtained online at DEQ and USGS's websites or other mapping tools.

Provide the estimated starting and ending dates of the construction or site or project. The date must be provided in DD-MM-YYYY where YY is the year, MM is the month and DD is the date.

Provide total area of construction site, and estimated area to be disturbed in acres.

Provide total impervious area (pre-construction) and total impervious area construction completed (post-construction) in acres.

Provide post-construction runoff coefficient of the site after the construction addressed in the NOI is completed. Operator may use recommended runoff coefficients in Addendum I of this permit. Average coefficients for composite area may be calculated on an area weighted basis from  $C = \frac{\sum C_i A_i}{\sum A_i}$  Where  $C_i$  is the coefficient applicable to the area  $A_i$ .

Describe the nature of fill material and existing soil data describing soils (i.e., coarse-grained soils: gravels, sands, or fine-grained soils: silts and clays, silts and clays, and highly organic soils etc.). Operator may use soil classification chart in Attachment I of Addendum H to determine the types of the soils on the sites.

Indicate whether this is the site of the common plan of development or sale.

Complete the section on Endangered Species Eligibility by checking the appropriate box: (a) the site/project is not located within any of the corridors of the Federal or State identified Aquatic Resources of Concern (ARC) and further investigation is not required; or (b) the site/project is located within a corridor of a Federal or State identified ARC. Operator agrees to implement the control measures specified in Step 2 of Part 10.2 of this permit; or (c) If one of those eligibility criteria under Part 1.2.2.E.2.b, d, or e cannot be met, operator may use Addendum H Buffer Requirements to evaluate alternatives of buffer requirements and select equivalent sediment controls or contact DEQ for further consultation; or (d) operator's federally approved construction activities are authorized by the appropriate Federal or State agency and that authorization addresses the Endangered Species Act Section 7 consultation for the operator's stormwater discharge or stormwater-related activities. Operator selecting option d must include documentation from US Fish and Wildlife Service (USFWS) or a qualified biologist that demonstrates Section 7 consultation has been completed. The SWP3 must include any conditions resulting from that consultation; or (e) operator's stormwater discharges and stormwater-related activities were already addressed in another operator's certification of eligibility under Part 1.3.2.E.2.d that included the proposed site/project area. Operator agrees to comply with any conditions attached to that certification.

### Section III. Site/Project Discharge Information

Indicate whether the site/project discharges stormwater to a Municipal Separate Storm Sewer System (MS4), if yes; enter the name of the MS4 operator. A MS4 is defined as a conveyance or system of conveyances, including roads with drainage systems, municipal streets, catch basins, curbs, gutters, ditches, man-made channels, or storm drains that are owned or operated by a state, city, town, borough, parish, district, association, or other public body which is designed or used for collecting or conveying stormwater.

Identify all the receiving waterbodies from the sites that discharge stormwater, including names of those waterbodies. Check appropriate box if the receiving waterbody is listed in DEQ 303(d) impaired waterbodies or drained to the watershed with approved Total Maximum Daily Loads (TMDL) report. Identified the pollutant(s) for which the waterbody is impaired.



## Instructions for Completing NOI Form 606-002A for Stormwater Discharges Associated with Construction Activity on Sites of One or more acres under the OPDES Construction General Permit OKR10

### Section IV. Stormwater Pollution Prevention Plan (SWP3)

#### Information

All site/projects eligible for coverage under the CGP OKR10 permit must prepare a SWP3 prior to submitting the NOI to DEQ. The SWP3 is intended to document the selection, design, and installation of different control measures to meet the permit's non-numeric technology based effluent limitations, if applicable, numeric effluent limitations, and water quality based effluent limitations contained in Part 3 of the Permit as well as to document compliance with other permit requirements. The SWP3 must be prepared in accordance with good engineering practices and to industry standards.

Check appropriate box whether the SWP3 has been prepared and is available on site.

Check appropriate box if the operator has registered for construction activities with the Secretary of State of Oklahoma.

List all the proposed Best Management Practices (BMPs) for construction activities. Operator must describe the proposed measures, including BMPs to control pollutants in stormwater discharges during construction. Specify any BMPs to be used if additional erosion and sediment controls are required by local government or due to specific site conditions.

List all the post-construction proposed Best Management Practices (BMPs) for construction activities. Operator must describe the proposed measures to be used to control pollutants in stormwater discharges that will occur after construction operations have been complete, including any BMPs to be used if additional erosion and sediment controls are required by local government or due to specific site conditions.

### Section V. Certification

Federal regulations require all permit applications and report shall be signed as follows:

For a corporation: by a responsible corporate officer, which means: (i) a president, secretary, treasurer, or vice-president of the corporation in charge of a principal business function, or any other person who performs similar policy or decision making functions for the corporation, or (ii) the manager of one or more manufacturing, production, or operating facilities, provided, the manager is authorized to make management decisions which govern the operation of the regulated facility including having the explicit or implicit duty of making major capital investment recommendations, and initiating and directing other comprehensive measures to assure long term environmental compliance with environmental law and regulations; the manager can ensure that the necessary systems are established or actions taken to gather complete and accurate information for permit application requirements; and where authority to sign documents had been assigned or delegated to the manager in accordance with corporate procedures;

For a partnership or sole proprietorship: by a general partner or the proprietors, respectively (*Note: for limited liability company (LLC) - by one of its owners, called managing members/partners of the company*); or

For a municipality, state, Federal, or other public facility: by either a principal executive or ranking elected official.

### Modifying Existing Notice Of Intent (NOI)

After issuance of an authorization, an amended NOI may be submitted by a permittee if circumstances change (e.g., the area to be disturbed has been changed from 20 acres to 40 acres). However, the modification of an NOI cannot be used if the area to be disturbed has been changed from 40 acres to 20 acres. The amended NOI shall include the operator's assigned authorization number and request a change.

The original authorization number will be retained. DEQ will provide an acknowledgement by either mail or email that the amended NOI has been received and processed. Permittees must update their SWP3 to reflect the modification.

### Submitting Your NOI Form

Completed NOI form must be submitted to the following address:

Stormwater Unit of ECLS  
Oklahoma DEQ  
P.O. Box 1677, Oklahoma City, OK 73101-1677  
or fax it to: (405)702-6226  
or email it to: [ecls-stormwaterpermitting@deq.ok.gov](mailto:ecls-stormwaterpermitting@deq.ok.gov)

All applicable fees must be submitted with this NOI, including:

- Renewal NOI - \$100 application fee
- New NOI - \$447.71 (\$100 application fee and \$347.71 annual permit fee)

*Note: Commencing December 21, 2020, NOI must be electronically submitted to DEQ. Instructions on how to access and use the appropriate electronic reporting tool will be made available on DEQ's website prior to the December 21, 2020 compliance deadline.*

*Do not submit an SWP3 with the NOI unless the site/project is located (1) within Outstanding Resource Waters (ORW), or (2) within a Federal and State ARC, or (3) within a Watershed that is subject to an approved TMDL, and/or watershed plan and/or local compliance plan and such site to be disturbed is about 5 acres or more, or (4) within a larger site which is disturbing land of 40 or more acres.*



DEQ Form  
606-003  
July 5, 2017



**Oklahoma Department of Environmental Quality  
Notice of Termination (NOT)  
for Stormwater Discharges Associated with Industrial Activity  
or Construction Activity under an OPDES General Permit**

Submission of this NOT form constitutes notice that the operator identified in Section II of this form no longer intends to be authorized to discharge stormwater associated with industrial or construction activity under an OPDES Stormwater General Permit. Authorization is not terminated until you are notified that all termination requirements have been met and your complete NOT has been processed by DEQ.

All necessary information must be provided on this form. See completing instructions on the back of this form.

### I. Permit Information

DEQ Authorization Number: OKR \_\_\_\_\_

Reason for Termination (check one only):

- A new owner or operator has taken over responsibility for the facility/site/project and has submitted an NOI for permit coverage.
- Stormwater discharge from industrial activity is being terminated under OKR05 permit.
- All construction activities have been completed and met all other requirements under OKR10 permit including final stabilization on all portion of the site.
- You obtained coverage under an individual or alternative general permit for all stormwater discharges.

### II. Operator Information

Operator Name: \_\_\_\_\_ Phone: \_\_\_\_\_

Mailing Address: \_\_\_\_\_ City: \_\_\_\_\_

County: \_\_\_\_\_ State: \_\_\_\_\_ Zip Code: \_\_\_\_\_ E-mail: \_\_\_\_\_

### III. Facility/Site/Project Information

Facility or Site Name: \_\_\_\_\_

Address: \_\_\_\_\_

City: \_\_\_\_\_ County: \_\_\_\_\_ State: OK Zip Code: \_\_\_\_\_

Latitude: \_\_\_\_\_ Longitude: \_\_\_\_\_ at the entrance of the facility or center of the site

*(Note: You must include an updated facility map or site map that shows all the completed activities.)*

### IV. New Operator Information

New Operator Name: \_\_\_\_\_ Phone: \_\_\_\_\_

Address: \_\_\_\_\_ City: \_\_\_\_\_

County: \_\_\_\_\_ State: OK Zip Code: \_\_\_\_\_ E-mail: \_\_\_\_\_

*(Note: Use additional sheets of paper if necessary. Permittee is required to prepare a Notification of Change of Ownership for each new operator)*

### V. Certification

*I certify under penalty of law that all stormwater discharges associated with industrial or construction activity from the identified facility that were authorized by a general permit have been eliminated or that I am no longer the operator of the facility or construction site. I understand that by submitting this NOT form and upon receiving the termination letter from DEQ that the all termination requirements have been met and the complete NOT has been processed, I am no longer authorized to discharge stormwater associated with industrial or construction activity under the General Permit OKR05 or OKR10 to waters of the State. It is unlawful under the Clean Water Act and OAC 252:606-1-3(b)(3)(L) where the discharge is not authorized by an OPDES permit. I also understand that the submittal of this NOT form does not release me as operator from liability for any violations of this Permit or the Clean Water Act.*

Print Name: \_\_\_\_\_ Title: \_\_\_\_\_

Signature: \_\_\_\_\_ Date: \_\_\_\_\_



## Instructions for Completing NOT Form 606-003 for Stormwater Discharges Associated with Industrial or Construction Activity

### Who May File a Notice of Termination Form

The Permittee currently covered by the OKR05 (Industrial) or OKR10 (Construction) General Permit for stormwater discharges associated with industrial or construction activity must submit a Notice of Termination (NOT) within 30 days after one or more of the following conditions have been met:

- A new owner or operator has taken over responsibility for the facility or site or project, and has submitted an NOI for permit coverage.
- Stormwater discharge from industrial activity is being terminated under the OKR05 permit.
- All construction activities have completed and met all other requirements under the OKR10 permit, including final stabilization, on all portions of the site. (See Part 3.3.2.B of the OKR10 permit for specific requirement on final stabilization).
- You obtained coverage under an individual or alternative general permit for all discharges.

You must meet all of the termination requirements of the general permit prior to submitting the NOT.

#### Section I. Permit Information

Provide the current OPDES General Permit number assigned to the facility or the site identified in Section II. Indicate your Reason for submitting this NOT by checking the appropriate box.

#### Section II. Operator Information

Provide the legal name of the company, firm, public organization or any other entity that operates the facility or site described in this NOT. Provide the operator's phone number, mailing address, and email address.

#### Section III. Facility Information

Provide the legal name of the facility or site or project and complete street address, including city, county, state, and ZIP code of the facility or site. If the facility or site lacks a street address, indicate the general location of the facility (e.g., Intersection of State Highways 74 and 34).

Provide the latitude and longitude at the entrance of the facility or site or the center of the construction project or site. Latitude and Longitude can be obtained online at DEQ, USGS, or by using other mapping tools.

You must also include an updated facility map or site map that shows all disturbed areas over the course of your construction/project (i.e., aerial images or general site maps with project extents marked, including stabilized areas of concrete or asphalt batch plants, equipment staging yards, stockpile, borrow areas, wash-out area, etc.) with this form.

#### Section IV. New Operator Information

If applicable, provide the legal name of the company, firm, public organization or any other entity that has assumed ownership for the facility or site described in this NOT.

Provide phone number, complete physical address including city, state, ZIP code, and email address. If there is more than one new operator, use additional sheet(s) to include all the new operators' information.

Permittee is required to prepare and submit a Notification of Change of Ownership (NCO) form for each new owner and submit the NCO form to DEQ (see Part 2.3.3 of OKR10 for change of ownership requirement). NCO forms may be submitted at the change of ownership or with the NOT.

#### Section V. Certification

The NOT form must be signed as follows:

**For a corporation:** by a responsible corporate officer. For the purpose of this Section, a responsible corporate officer means: (i) a president, secretary, treasurer, or vice-president of the corporation in charge of a principal business function, or any other person who performs similar policy- or decision-making functions for the corporation, or (ii) the manager of one or more manufacturing, production, or operating facilities, provided, the manager is authorized to make management decisions which govern the operation of the regulated facility including having the explicit or implicit duty of making major capital investment recommendations, and initiating and directing other comprehensive measures to assure long-term environmental compliance with environmental laws and regulations; the manager can ensure that the necessary systems are established or actions taken to gather complete and accurate information for permit application requirements; and where authority to sign documents has been assigned or delegated to the manager in accordance with corporate procedures;

**For a partnership or sole proprietorship:** by a general partner or the proprietor, respectively (*Note: for limited liability company (LLC) - by one of its owners, called managing members/partners of the company*);

**For a municipality, state, Federal, or other public facility:** by either a principal executive officer or ranking elected official.

Include the name and title of the person signing the form and the date of signing.

**An unsigned or undated NOT form will not be processed for termination of permit coverage.**

*If you have questions, contact Stormwater Unit of Environmental Complaints and Local Services (ECLS) of DEQ at (405) 702-6100 or email to [ecls-stormwaterpermitting@deq.ok.gov](mailto:ecls-stormwaterpermitting@deq.ok.gov)*

Where to File an NOT form:

Completed NOT must be submitted to the following address:

Stormwater Unit of ECLS  
Oklahoma DEQ  
P.O. Box 1677  
Oklahoma City, Oklahoma 73101-1677

or fax it to: (405)702-6226

or email it to: [ecls-stormwaterpermitting@deq.ok.gov](mailto:ecls-stormwaterpermitting@deq.ok.gov)

*Commencing December 21, 2020, NOT must be electronically submitted to DEQ. Instructions on how to access and use the appropriate electronic reporting tool will be made available on DEQ's website prior to the December 21, 2020 compliance deadline.*

## SWPPP Template Form

To help you develop the narrative section of your construction site SWPPP, the Oklahoma Department of Environmental Quality (ODEQ) has created this electronic SWPPP template. The template is designed to help guide you through the SWPPP development process and help ensure that your SWPPP addresses all the necessary elements stated in your construction general permit. You should use this template with ODEQs guidance on Developing Your Stormwater Pollution Prevention Plan. Both are available on ODEQs website at <http://www.deq.state.ok.us/wqdnew/stormwater/constructionsw/index.html>

### Using the SWPPP Template

Each section of this template includes “instructions” and space for project information. You should read the instructions for each section before you complete that section. This template was developed in Word so that you can easily add tables and additional text. Some sections may require only a brief description while others may require several pages of explanation.

Tips for completing the SWPPP template:

- If there is more than one construction operator for your project, consider coordinating development of your SWPPP with the other operators.
- Multiple operators may share the same SWPPP, but make sure that responsibilities are clearly described.
- Modify this SWPPP template so that it addresses the requirements in your construction general permit and meets the needs of your project. Consider adding permit citations in the SWPPP when you address a specific permit requirement.

# Corrective Action Report

Today's Date: \_\_\_\_\_

(You are only required to fill out this form if any of the corrective action triggering conditions occurs on your site. Routine maintenance and repairs are generally not considered to be a corrective action triggering condition.)

| <b>Section A: Initial Report (Part 4.3.14.B.1 of OKR10)</b><br>(Complete this section <u>within 24 hours</u> of discovering the condition that triggered corrective action)                                                                                                                                                                                                                                                                                                                                                                                                                                                                                                       |                                                                                |
|-----------------------------------------------------------------------------------------------------------------------------------------------------------------------------------------------------------------------------------------------------------------------------------------------------------------------------------------------------------------------------------------------------------------------------------------------------------------------------------------------------------------------------------------------------------------------------------------------------------------------------------------------------------------------------------|--------------------------------------------------------------------------------|
| <b>Name of Project:</b>                                                                                                                                                                                                                                                                                                                                                                                                                                                                                                                                                                                                                                                           | DEQ's Permit No. OKR10                                                         |
| <b>Date Problem First Discovered:</b>                                                                                                                                                                                                                                                                                                                                                                                                                                                                                                                                                                                                                                             | <b>Time Problem First Discovered:</b>                                          |
| <b>Name &amp; Contact Information of the Individual:</b>                                                                                                                                                                                                                                                                                                                                                                                                                                                                                                                                                                                                                          |                                                                                |
| <b>What site conditions triggered the requirement to conduct corrective action (check the box that applies):</b><br><input type="checkbox"/> A required stormwater control was never installed or was installed incorrectly, or not in accordance with the corresponding OKR10 permit requirement<br><input type="checkbox"/> A stormwater control is not effective enough for the discharge to meet applicable water quality standards<br><input type="checkbox"/> A prohibited discharge (OKR10 Parts 3.1 and 3.3.3.A) is occurring or has occurred.<br><input type="checkbox"/> DEQ requires corrective action as a result of permit violations found during an DEQ inspection |                                                                                |
| <b>Provide a description of the problem:</b>                                                                                                                                                                                                                                                                                                                                                                                                                                                                                                                                                                                                                                      |                                                                                |
| <b>Deadline for completing corrective action:</b>                                                                                                                                                                                                                                                                                                                                                                                                                                                                                                                                                                                                                                 | <i>not more than 7 calendar days after the date you discovered the problem</i> |

| <b>Section B: Corrective Action Progress (Part 4.3.14.B.2 of OKR10)</b><br>(Complete this section <u>no later than 7 calendar days</u> after discovering the condition that triggered corrective action) |                                                       |                                                                                               |                          |
|----------------------------------------------------------------------------------------------------------------------------------------------------------------------------------------------------------|-------------------------------------------------------|-----------------------------------------------------------------------------------------------|--------------------------|
| <b>Section B.1: Why the Problem Occurred</b>                                                                                                                                                             |                                                       |                                                                                               |                          |
| Cause(s) of Problem                                                                                                                                                                                      | How It Was Determined & Date of Determining the Cause |                                                                                               |                          |
| 1.                                                                                                                                                                                                       | 1.                                                    |                                                                                               |                          |
| 2.                                                                                                                                                                                                       | 2.                                                    |                                                                                               |                          |
| <b>Section B.2: Stormwater Control Modifications to be Implemented to Correct the Problem</b>                                                                                                            |                                                       |                                                                                               |                          |
| Stormwater Control Modification(s) Needed to Correct Problem                                                                                                                                             | Date of Completion                                    | SWP3 Update Necessary?                                                                        | SWP3 Modifications Notes |
| 1.                                                                                                                                                                                                       |                                                       | <input type="checkbox"/> Yes <input type="checkbox"/> No, If yes, provide date SWP3 modified: |                          |
| 2.                                                                                                                                                                                                       |                                                       | <input type="checkbox"/> Yes <input type="checkbox"/> No, If yes, provide date SWP3 modified: |                          |

### Section C: Certification and Signature by Permittee

I certify under penalty of law that this document and all attachments were prepared under my direction or supervision in accordance with a system designed to assure that qualified personnel properly gathered and evaluated the information submitted. Based on my inquiry of the person or persons who manage the system, or those persons directly responsible for gathering the information, the information submitted is, to the best of my knowledge and belief, true, accurate, and complete. I am aware that there are significant penalties for submitting false information, including the possibility of fine and imprisonment for knowing violations.

**Name:** \_\_\_\_\_ **Title:** \_\_\_\_\_

**Signature:** \_\_\_\_\_ **Date:** \_\_\_\_\_

# SWP3 Employee Training Report

Project Name: \_\_\_\_\_ DEQ Authorization No. OKR10 \_\_\_\_\_

Instructor's Name: \_\_\_\_\_ Instructor's Title: \_\_\_\_\_

Course Location: \_\_\_\_\_ Date: \_\_\_\_\_

Course Length (hours): \_\_\_\_\_

Stormwater Training Topic: *(check as appropriate)*

- |                                                                   |                                                              |
|-------------------------------------------------------------------|--------------------------------------------------------------|
| <input type="checkbox"/> Overview of SWP3                         | <input type="checkbox"/> Temporary & Permanent Stabilization |
| <input type="checkbox"/> Erosion & Sediment Controls Installation | <input type="checkbox"/> Good Housekeeping                   |
| <input type="checkbox"/> Erosion & Sediment Controls Maintenance  | <input type="checkbox"/> Inspections and Corrective Actions  |
| <input type="checkbox"/> Spill Prevention & Response              | <input type="checkbox"/> Emergency Procedures                |

Specific Training Objective: \_\_\_\_\_

---

Attendee Roster: *(attach additional pages as necessary)*

| No. | Name of Attendee | Signature of the Attendees | Date |
|-----|------------------|----------------------------|------|
| 1.  |                  |                            |      |
| 2.  |                  |                            |      |
| 3.  |                  |                            |      |
| 4.  |                  |                            |      |
| 5.  |                  |                            |      |
| 6.  |                  |                            |      |
| 7.  |                  |                            |      |
| 8.  |                  |                            |      |
| 9.  |                  |                            |      |
| 10. |                  |                            |      |
| 11. |                  |                            |      |
| 12. |                  |                            |      |

# 7

## BMP DETAIL SHEETS

### **7. Best Management Practices Detail Sheets**

- 7.1 Silt Fence
- 7.2 Triangular Silt Dikes
- 7.3 Straw Wattle Installation
- 7.4 Temporary Rock Construction Entrance/Exit
- 7.5 Temporary Rock Construction Entrance/Exit for Steep Grades
- 7.6 Rock Bag Silt Fence
- 7.7 Rock Check Dams
- 7.8 Rock Bag Check Dams
- 7.9 Rock Bag Curb Inlet Barrier
- 7.10 Rock Bag/Filter Mat Drop Inlet Sediment Barrier
- 7.11 Curb Inlet Filter Mat Sediment Barrier
- 7.12 Curb Inlet Sediment Bag
- 7.13 Drop Inlet Sediment Bag
- 7.14 New Roadways
- 7.15 Concrete Flume
- 7.16 Erosion Blanket & Turf Reinforcement Mats – Slope Installation
- 7.17 Erosion Blanket & Turf Reinforcement Mats – Channel Installation
- 7.18 Energy Dissipater
- 7.19 Typical Sediment Basin
- 7.20 Typical Earth Dike
- 7.21 Surface Concrete Washout Area
- 7.22 Above Ground Concrete Washout Area
- 7.23 Silt Rock Installation

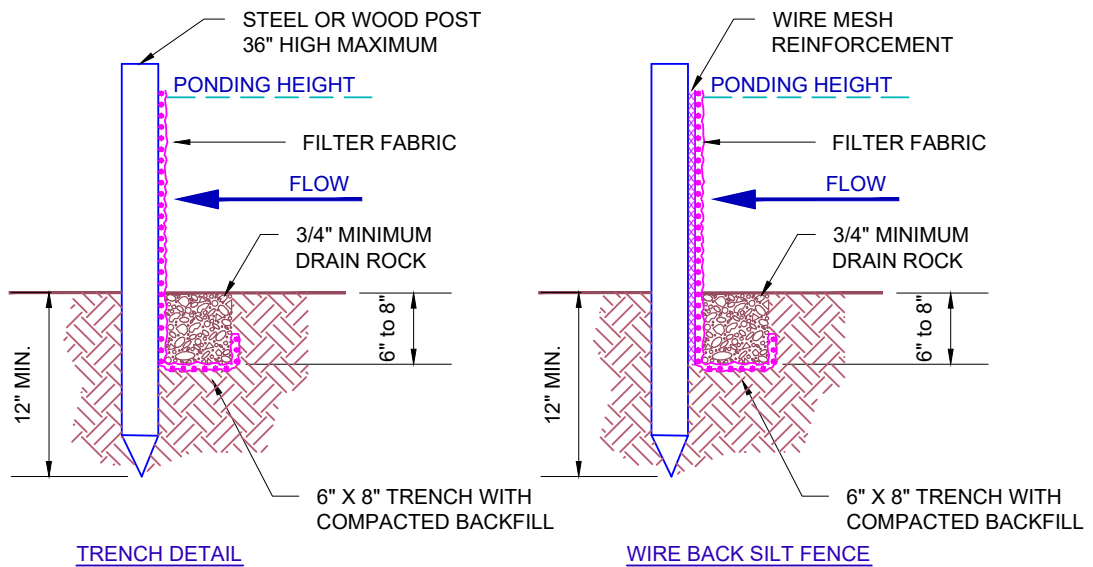
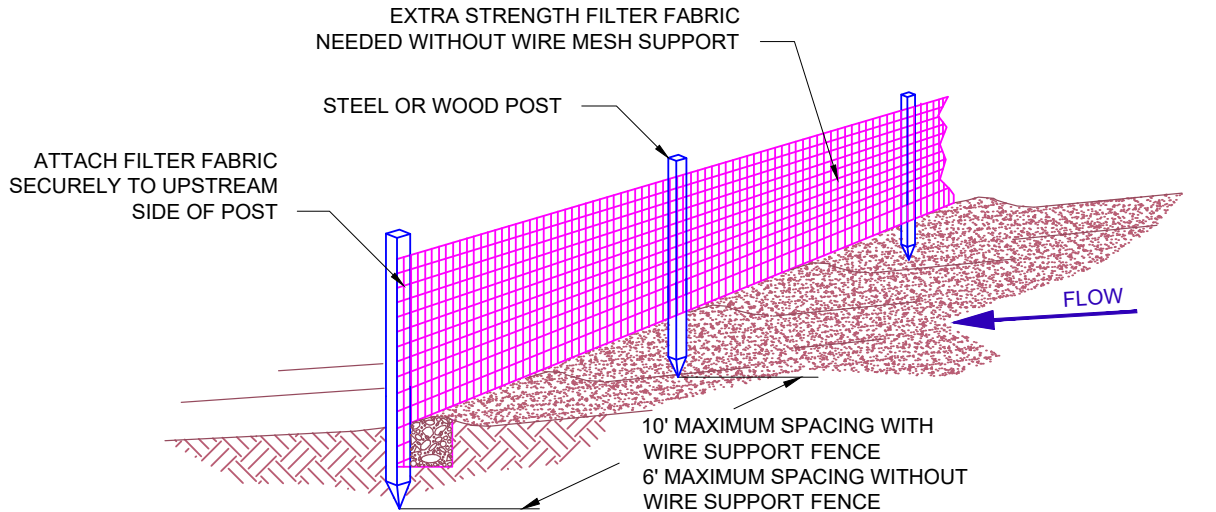

**NOTES:**

1. MUST BE INSTALLED PROPERLY TO AVOID NOTICE OF VIOLATION.
2. SILT FENCE SHALL BE PLACED ON SLOPE CONTOURS TO MAXIMIZE POUNDING EFFICIENCY.
3. INSPECT AND REPAIR FENCE AFTER EACH STORM EVENT AND REMOVE SEDIMENT WHEN NECESSARY. ACCUMULATED SEDIMENT SHOULD BE REMOVED FROM THE FENCE BASE WHEN THE SEDIMENT REACHES ONE-THIRD TO ONE-HALF THE FENCE HEIGHT.
4. REMOVED SEDIMENT SHALL BE DEPOSITED TO AN AREA THAT WILL NOT CONTRIBUTE TO SEDIMENT OFF-SITE AND CAN BE PERMANENTLY STABILIZED.

**SILT FENCE**

STORM WATER QUALITY  
MANAGEMENT DIVISION

ERIC J. WENGER, P.E.  
CITY ENGINEER  
DATE: 03-04-13  
DRAWN: VSC  
DATE: 03-04-13



The City of  
**Oklahoma City**  
Public Works Department  
Engineering Division

FORM  
7.1

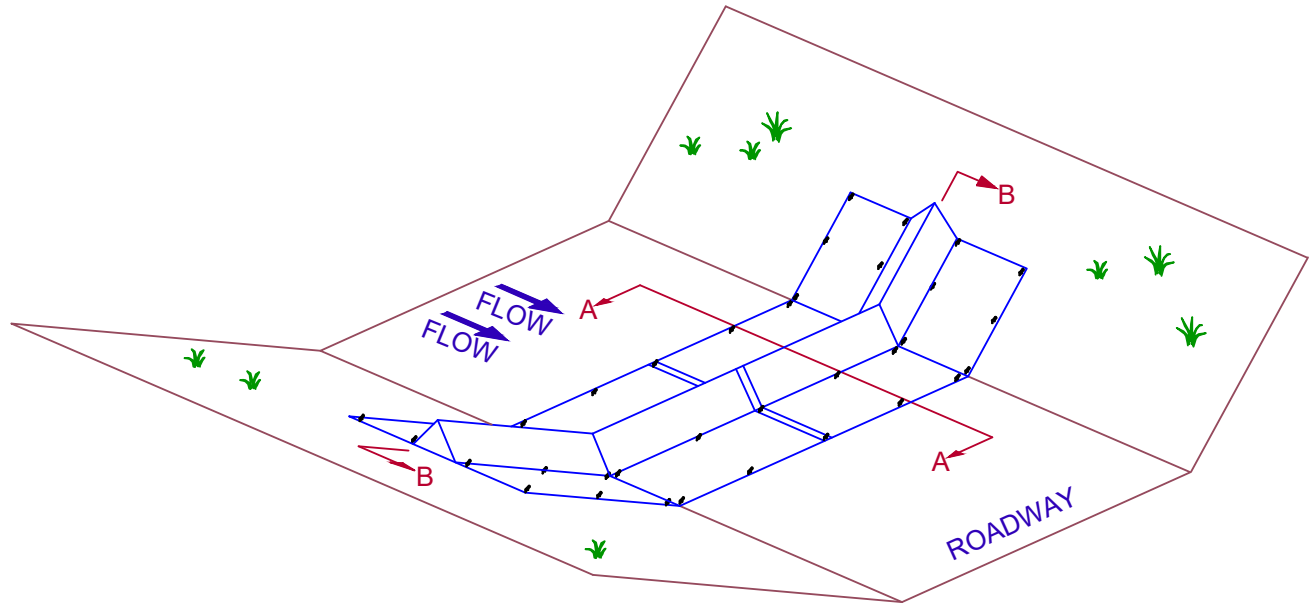

**SILT DAM UNIT  
CUT SECTION**

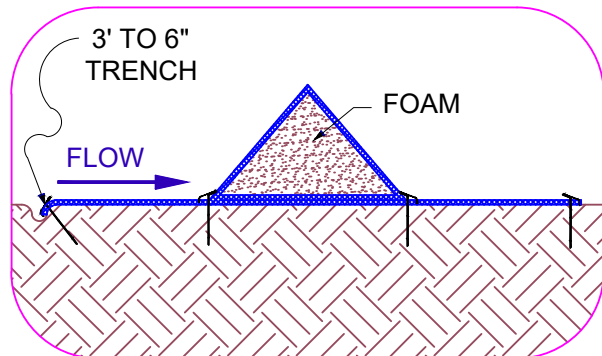

**DETAIL A--A**

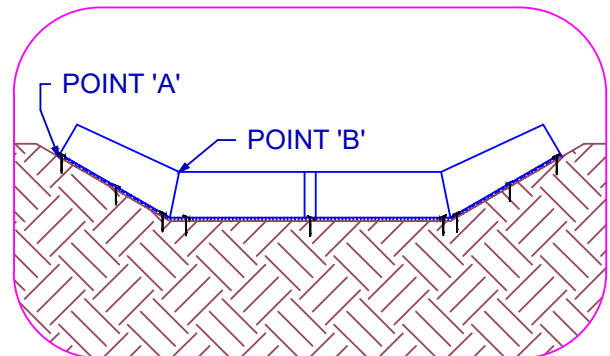

**DETAIL B--B**

**NOTES:**

1. STAPLES SHALL BE PLACED WHERE THE UNITS OVERLAP AND IN THE CENTERS OF THE 7' UNIT AS SHOWN IN DETAILS.
2. POINT 'A' MUST BE HIGHER THAN POINT 'B' TO ENSURE THAT THE WATER FLOWS OVER THE DAM AND NOT AROUND THE ENDS.

**TRIANGULAR SILT DIKES**

**STORM WATER QUALITY  
MANAGEMENT DIVISION**

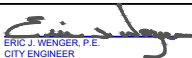
|                                                                                                                              |          |                |
|------------------------------------------------------------------------------------------------------------------------------|----------|----------------|
| <br>ERIC J. WENGER, P.E.<br>CITY ENGINEER |          | DATE: 03-04-13 |
| DRAWN:                                                                                                                       | VSC      |                |
| DATE:                                                                                                                        | 03-04-13 |                |



**The City of  
Oklahoma City**  
Public Works Department  
Engineering Division

**FORM  
7.2**



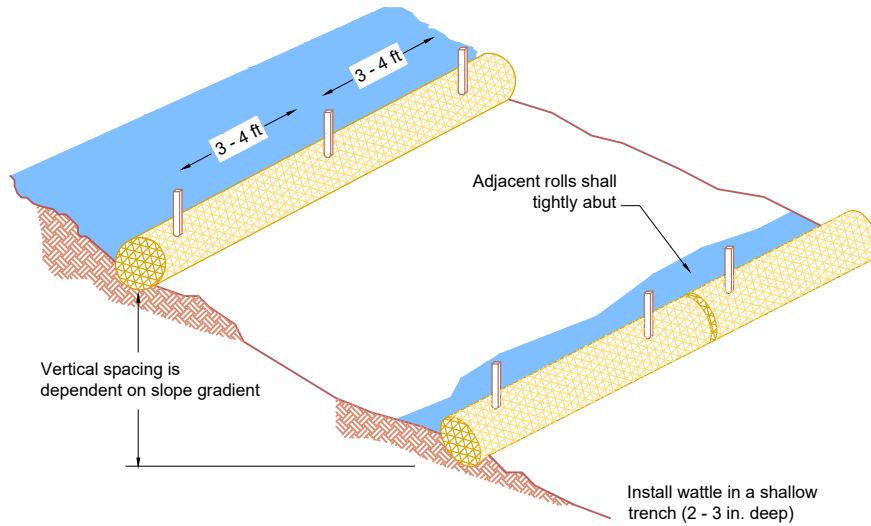

**Typical Wattle Installation Guide**

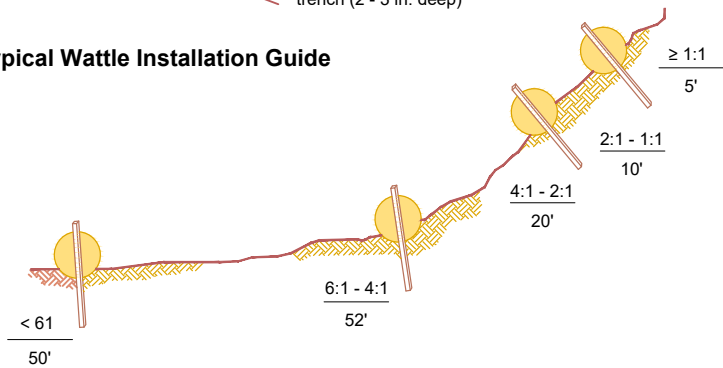

**Typical Wattle Spacing based on Slope Gradient**

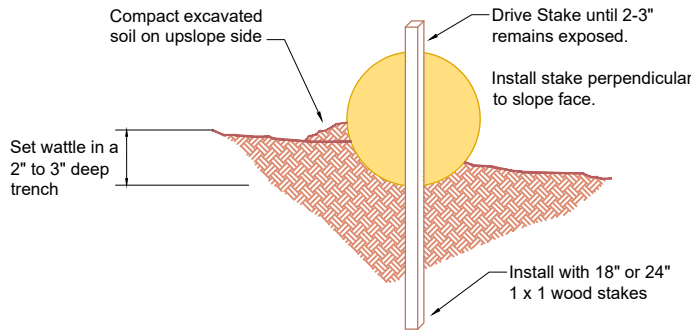

**Enrichment Detail**

**NOTES:**

1. Begin at the location where the wattle is to be installed by excavating a 2 - 3" deep x 9" wide trench along the contour of the slope. Excavated soil should be placed up-slope from the anchor trench.
2. Place the wattle in the trench so that it contours to the soil surface. Compact the soil from the excavated trench against the wattle on the uphill side. Adjacent wattles should tightly abut.
3. Secure the wattle with 18 - 24" stakes every 3 - 4' With a stake on each end. Stakes should be driven through the middle of the wattles leaving at least 3" of stake extending above, the wattle stakes should be driven perpendicular to slope face.

**STRAW WATTLE INSTALLATION**

STORM WATER QUALITY  
MANAGEMENT DIVISION

ERIC J. WENGER, P.E.  
CITY ENGINEER  
DATE: 03-04-13  
DRAWN: VSC  
DATE: 03-04-13



The City of  
Oklahoma City  
Public Works Department  
Engineering Division

FORM  
7.3



**SECTION A -- A**

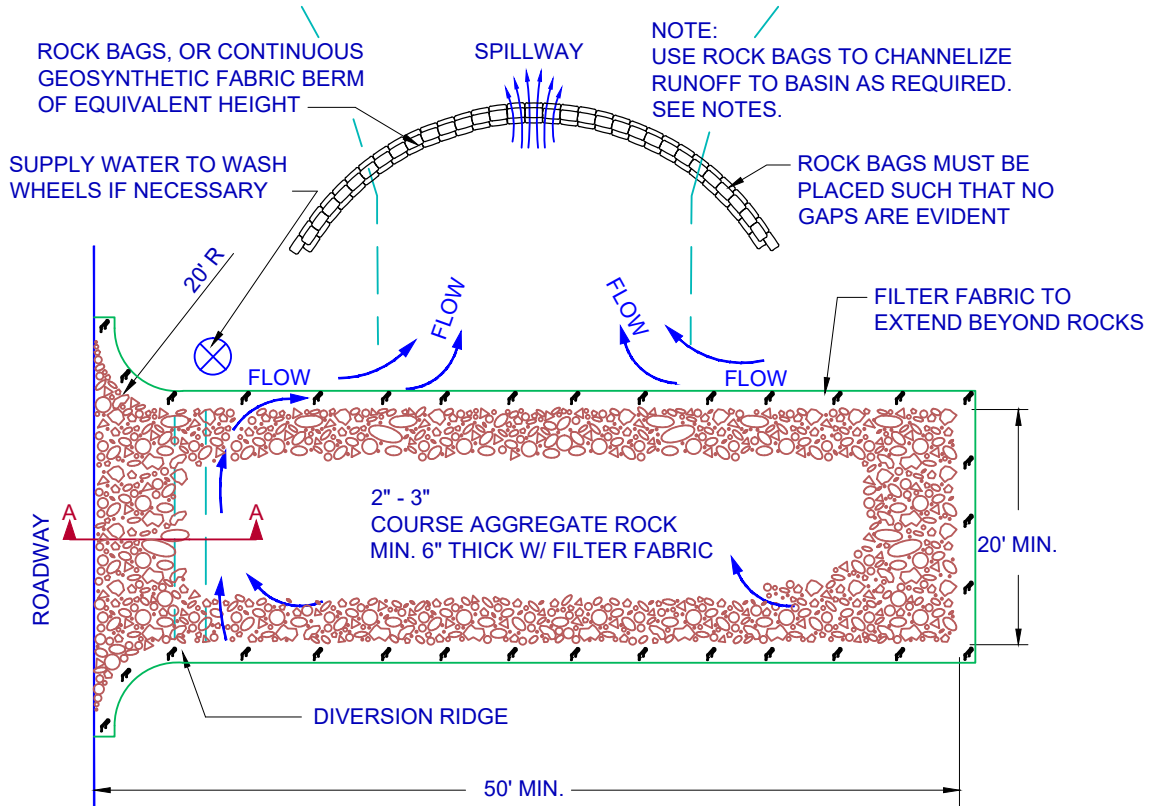

**PLAN**

**NOTES:**

1. THE ENTRANCE SHALL BE MAINTAINED IN A CONDITION THAT WILL PREVENT TRACKING OR FLOWING OF SEDIMENT ONTO PUBLIC RIGHT-OF-WAYS. THIS MAY REQUIRE TOP DRESSING, REPAIR AND/OR CLEANOUT OF ANY MEASURES USED TO TRAP SEDIMENT.
2. WHEN NECESSARY, WHEELS SHALL BE CLEANED PRIOR TO ENTRANCE ONTO PUBLIC RIGHT-OF-WAY.
3. WHEN WASHING IS REQUIRED, IT SHALL BE DONE ON AN AREA STABILIZED WITH CRUSHED STONE THAT DRAINS INTO AN APPROVED SEDIMENT TRAP OR SEDIMENT BASIN.
4. BAGS OF WOVEN GEOTEXTILE FABRIC, FILLED WITH GRAVEL MUST BE LAYERED SUCH THAT NO GAPS ARE EVIDENT.

**TEMPORARY ROCK CONSTRUCTION ENTRANCE / EXIT**

STORM WATER QUALITY  
MANAGEMENT DIVISION

ERIC J. WENGER, P.E.  
CITY ENGINEER  
DATE: 03-04-13  
DRAWN: VSC  
DATE: 03-04-13



The City of  
**Oklahoma City**  
Public Works Department  
Engineering Division

FORM  
7.4

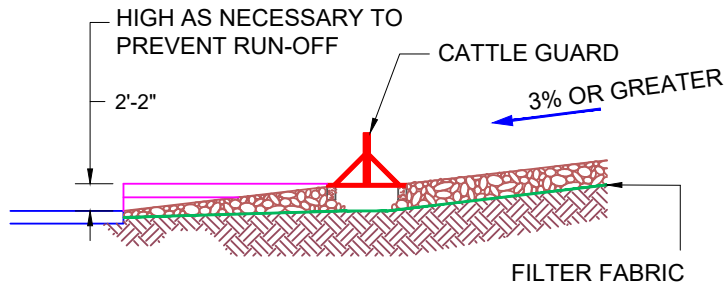

**SECTION A -- A**

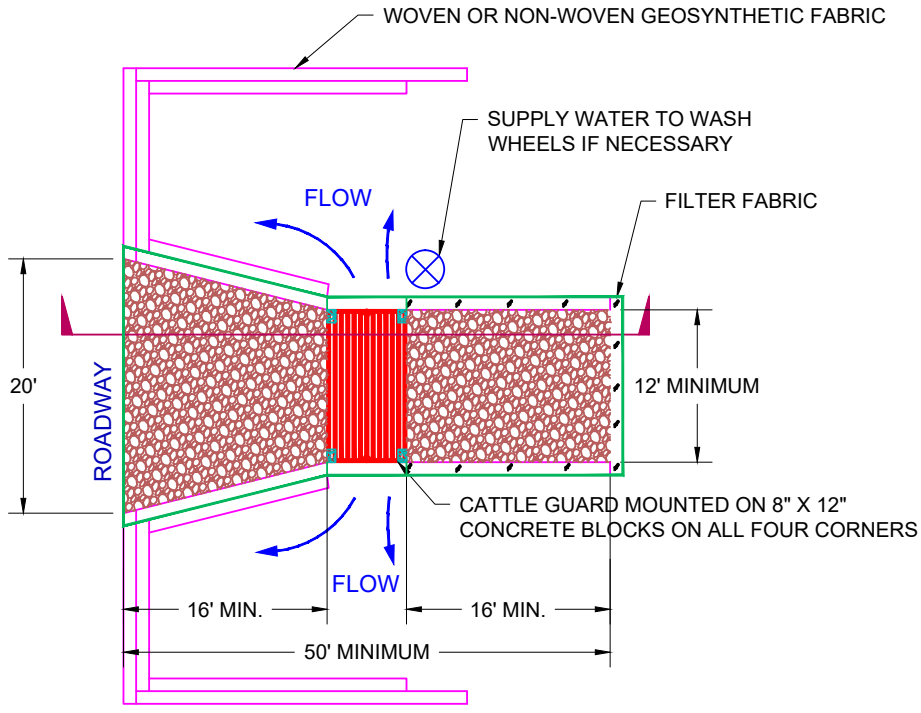
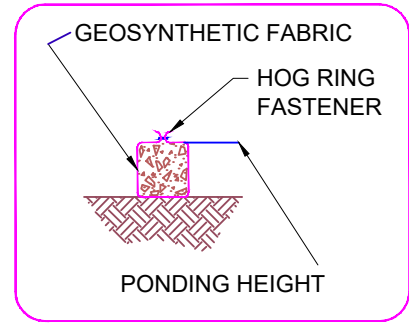

**PLAN**

**NOTES:**

1. THE ENTRANCE SHALL BE MAINTAINED IN A CONDITION THAT WILL PREVENT TRACKING OR FLOWING OF SEDIMENT ONTO PUBLIC RIGHT-OF-WAYS. THIS MAY REQUIRE A MOUNTED CATTLE GUARD AND SEDIMENT PONDS TO TRAP SEDIMENT.
2. WHEN NECESSARY, WHEELS SHALL BE CLEANED PRIOR TO ENTRANCE ONTO PUBLIC RIGHT-OF-WAY.
3. WHEN WASHING IS REQUIRED, IT SHALL BE DONE ON THE CATTLE GUARD. FIRST WASH ONE SET OF TIRES THEN, MOVE FORWARD TO WASH THE SECOND SET OF TIRES. THE GUARD IS TO BE MOUNTED ON 8" X 12" CEMENT BLOCK ON AN AREA OF STABILIZED CRUSHED STONE WITH A DRAIN INTO AN APPROVED SEDIMENT TRAP OR SEDIMENT BASIN ON BOTH SIDES.

**TEMPORARY ROCK CONSTRUCTION ENTRANCE / EXIT FOR STEEP GRADES**

STORM WATER QUALITY  
MANAGEMENT DIVISION

ERIC J. WIENGER, P.E.  
CITY ENGINEER  
DATE: 03-04-13  
DRAWN: VSC  
DATE: 03-04-13



The City of  
**Oklahoma City**  
Public Works Department  
Engineering Division

FORM  
7.5

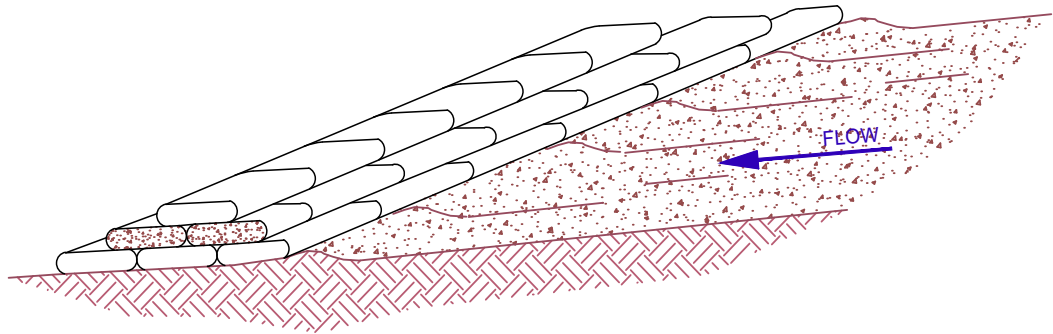

**SANDBAG BARRIER**

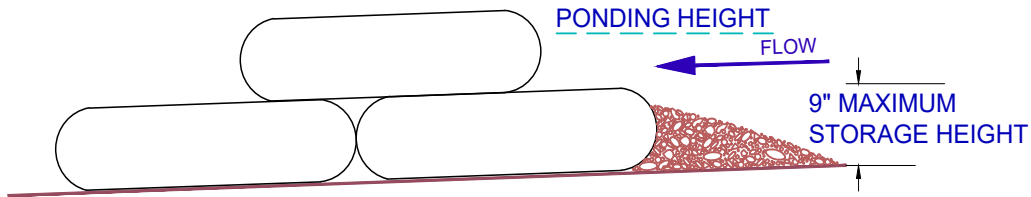

**ROCK BAG DETAIL**

**NOTES:**

1. A 'REASONABLE' DESIGN SIZE PARTICLE MUST BE SELECTED.
2. SIZE DISTRIBUTION OR UPSTREAM SOIL PARTICLES MUST BE EVALUATED.
3. INFLOW AND OUTFLOW FROM THE SYSTEM FOR A SPECIFIC FREQUENCY STORM MUST BE KNOWN.
4. POND VOLUME IS DIRECTLY PROPORTIONAL TO THE DISCHARGE RATE OF THE SYSTEM.
5. POND VOLUME IS INVERSELY PROPORTIONAL TO THE MASS OF THE DESIGN SIZE SUSPENDED PARTICLE.
6. A SYSTEM MUST PROVIDE SUFFICIENT FLOW TO ALLOW FOR DEPOSITION OF DESIGN PARTICLES.
7. THE PONDING HEIGHT MUST BE WELL BELOW THE GROUND ELEVATION DOWNSLOPE TO PREVENT RUNOFF FROM BYPASSING THE INLET. A TEMPORARY DIKE MAY BE NECESSARY ON THE DOWNSLOPE SIDE OF THE STRUCTURE.
8. ROCK BAG SILT BARRIER SHALL BE PLACED ON SLOPE CONTOURS TO MAXIMIZE POUNDING EFFICIENCY.
9. PLACE ROCK BAG SUCH THAT NO GAPS ARE EVIDENT.
10. INSPECT AND REPAIR FENCE AFTER EACH STORM EVENT AND REMOVE SEDIMENT WHEN NECESSARY. 9" MAXIMUM RECOMMENDED STORAGE HEIGHT.
11. REMOVED SEDIMENT SHALL BE DEPOSITED TO AN AREA THAT WILL NOT CONTRIBUTE TO SEDIMENT OFF-SITE AND CAN BE PERMANENTLY STABILIZED.

**ROCK BAG SILT FENCE**

**STORM WATER QUALITY  
MANAGEMENT DIVISION**

|                                       |                |
|---------------------------------------|----------------|
| ERIC J. WENGER, P.E.<br>CITY ENGINEER | DATE: 03-05-13 |
| DRAWN: VSC                            |                |
| DATE: 03-04-13                        |                |



**The City of  
Oklahoma City  
Public Works Department  
Engineering Division**

**FORM  
7.6**

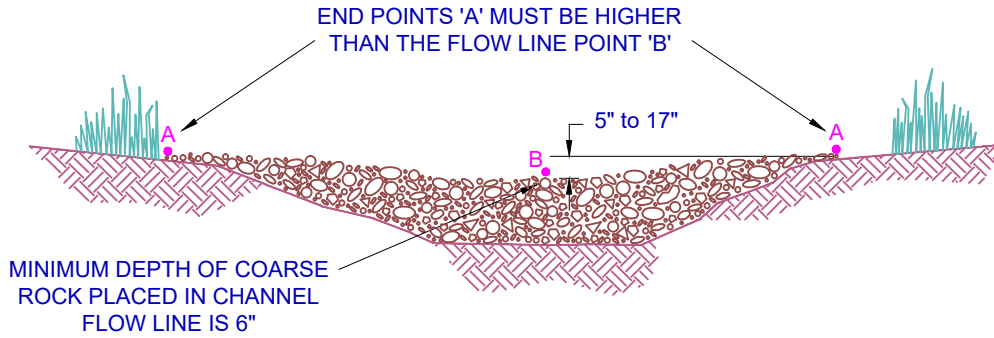

**VIEW LOOKING UPSTREAM**

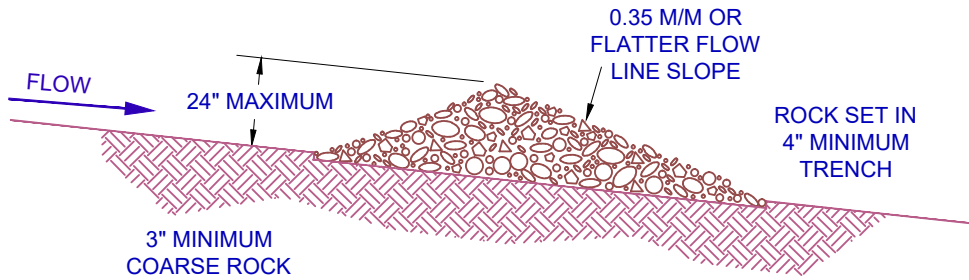

**SIDE VIEW**

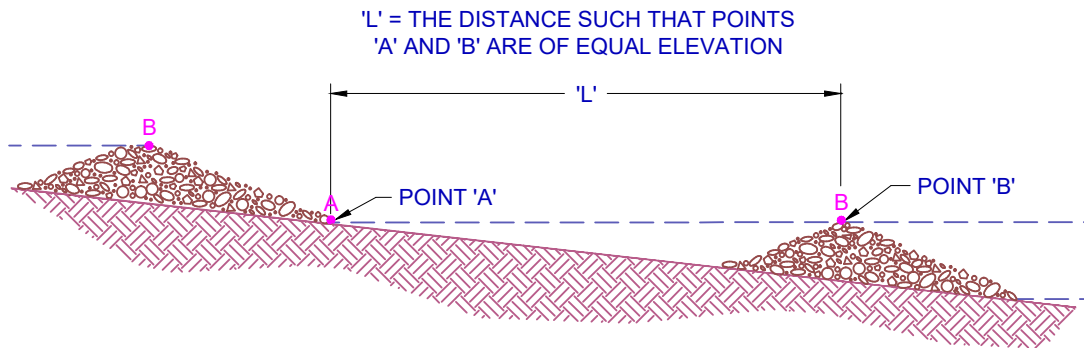

**SPACING BETWEEN CHECK DAMS**

| D-50<br>OF ROCK<br>(MM) | DOWNSTREAM FLOWLINE SLOPE OF STRUCTURE (M / M) |      |      |      |      |      |
|-------------------------|------------------------------------------------|------|------|------|------|------|
|                         | 0.35                                           | 0.30 | 0.25 | 0.20 | 0.15 | 0.10 |
| 75                      | 15                                             | 18   | 20   | 25   | 33   | 48   |
| 150                     | 30                                             | 36   | 41   | 50   | 66   | 100  |

**ROCK CHECK DAMS**

STORM WATER QUALITY  
MANAGEMENT DIVISION

ERIC J. WENGER, P.E.  
CITY ENGINEER  
DATE: 03-05-13  
DRAWN: VSC  
DATE: 03-04-13



The City of  
Oklahoma City  
Public Works Department  
Engineering Division

FORM  
7.7

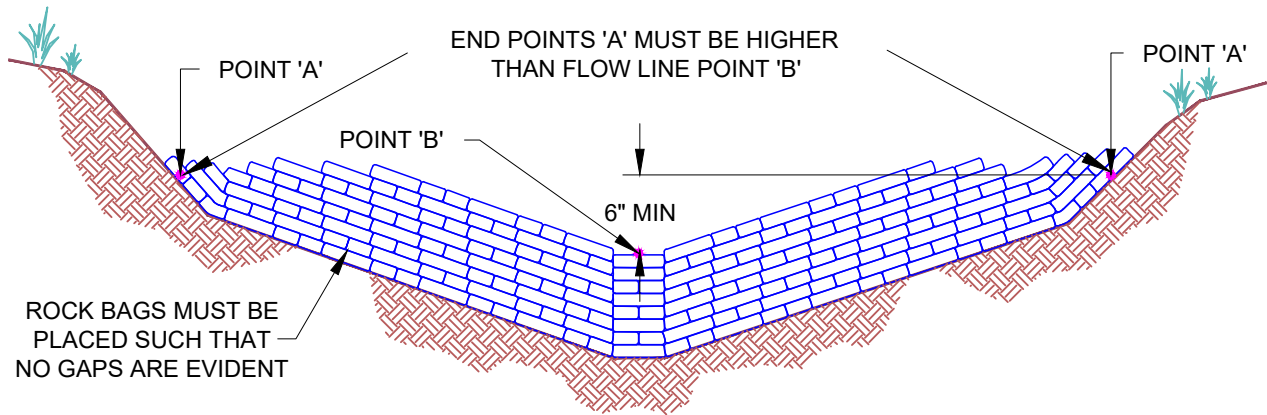

ROCK BAGS MUST BE PLACED SUCH THAT NO GAPS ARE EVIDENT

**VIEW LOOKING UPSTREAM**

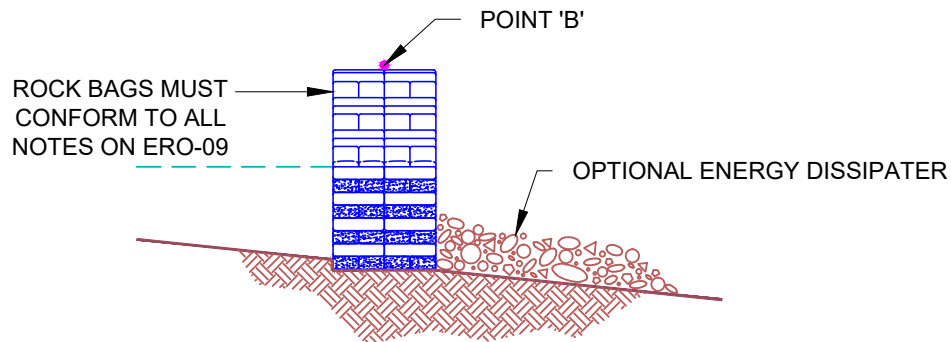

**SIDE VIEW**

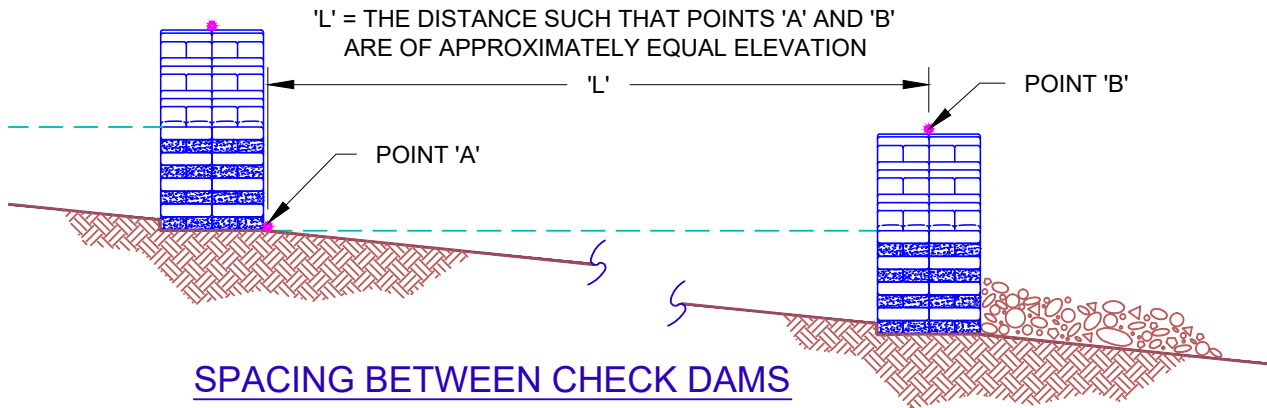

**SPACING BETWEEN CHECK DAMS**

**ROCK BAG CHECK DAMS**

STORM WATER QUALITY  
MANAGEMENT DIVISION

ERIC J. WENGER, P.E.  
CITY ENGINEER  
DATE: 03-06-13  
DRAWN: VSC  
DATE: 03-06-13



The City of  
**Oklahoma City**  
Public Works Department  
Engineering Division

FORM  
7.8

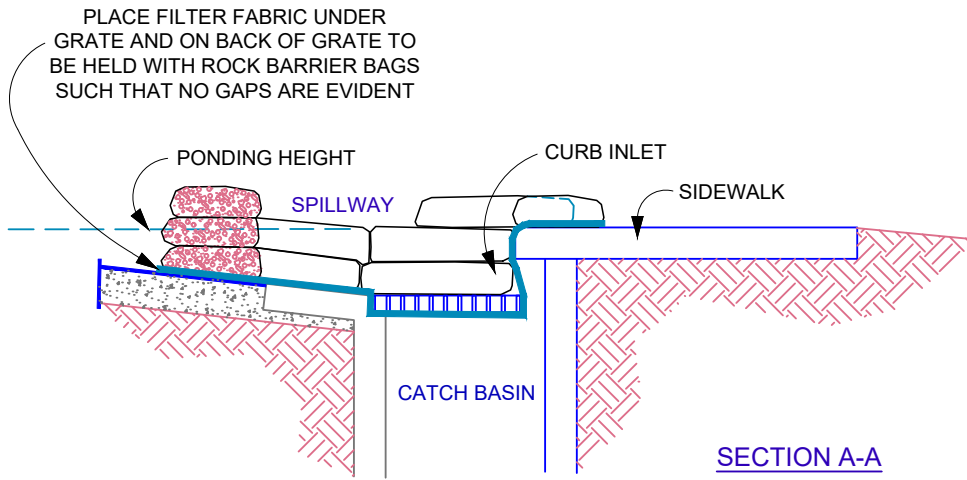
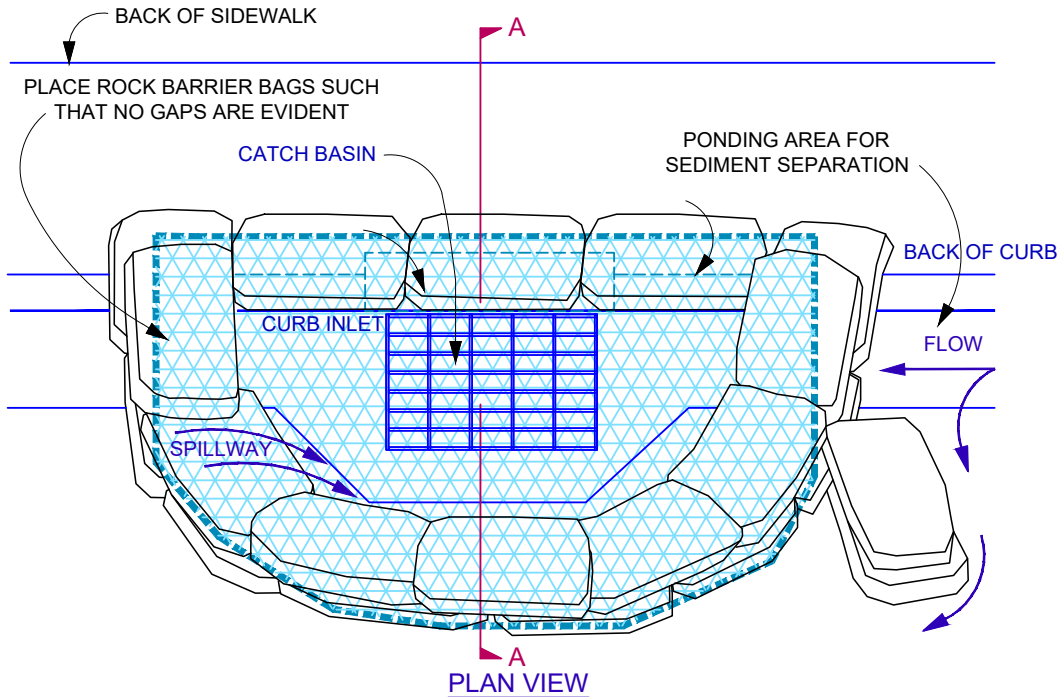

**NOTES:**

1. PLACE CURB TYPE ROCK BAG BARRIER ON GENTLY SLOPING STREET, WHERE WATER CAN POND AND ALLOW SEDIMENT TO SEPARATE FROM RUNOFF.
2. BAGS OF WOVEN GEOTEXTILE FABRIC, FILLED WITH GRAVEL MUST BE LAYERED SUCH THAT NO GAPS ARE EVIDENT.
3. LEAVE ONE SANDBAG GAP IN THE TOP ROW ON THE SIDE AWAY FROM FLOW, TO PROVIDE A SPILLWAY; OR IN THE CENTER IF PONDING IS NEEDED ON BOTH SIDES.
4. INSPECT BARRIERS AND REMOVE SEDIMENT AFTER EACH STORM EVENT, SEDIMENT AND GRAVEL MUST BE REMOVED FROM THE TRAVELED WAY IMMEDIATELY.

**ROCK BAG CURB INLET BARRIER**

STORM WATER QUALITY  
MANAGEMENT DIVISION

ERIC J. WENGER, P.E.  
CITY ENGINEER  
DATE: 03-06-13  
DRAWN: VSC  
DATE: 03-06-13



The City of  
**Oklahoma City**  
Public Works Department  
Engineering Division

FORM  
7.9

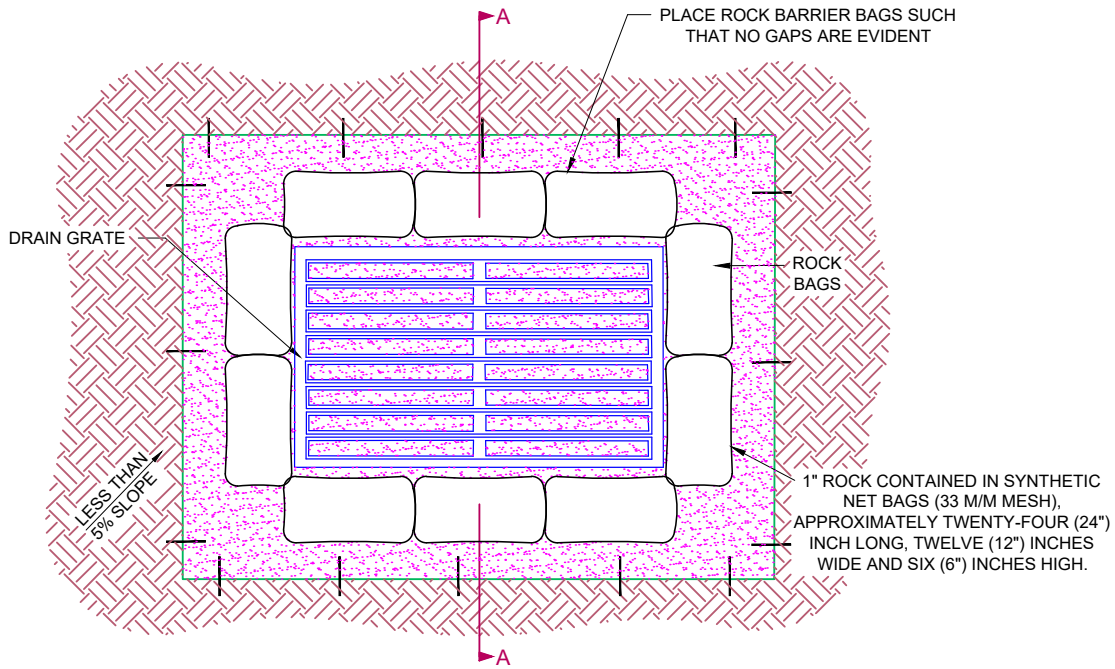

**PLAN VIEW**

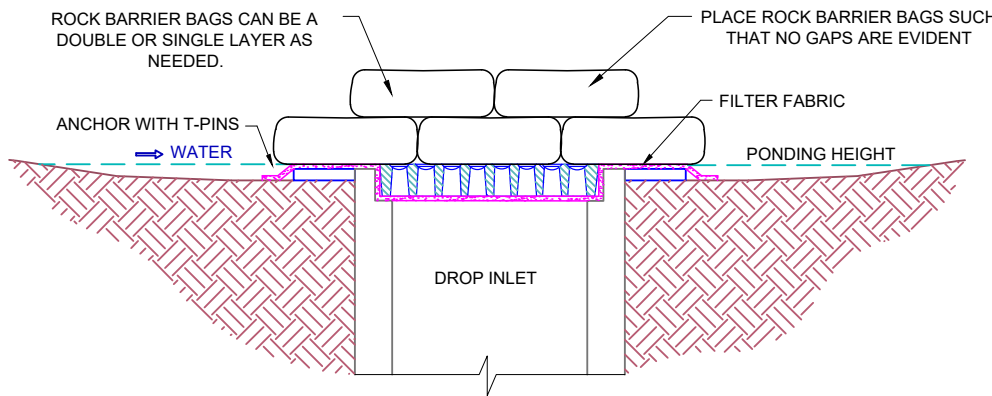

**SECTION**

**NOTE:**

1. DROP INLET SEDIMENT BARRIERS ARE TO BE USED FOR SMALL, NEARLY LEVEL DRAINAGE AREAS. (LESS THAN 5%)
2. USE T-PINS TO ANCHOR FIBER MAT INTO THE SOIL.
3. A "REASONABLE" DESIGN SIZE PARTICLE TO CAPTURE MUST BE SELECTED.
4. SIZE DISTRIBUTION OF UPSTREAM SOIL PARTICLES MUST BE EVALUATED.
5. INFLOW AND OUTFLOW FROM THE SYSTEM FOR A SPECIFIC FREQUENCY STORM MUST BE KNOWN.
6. POND VOLUME IS DIRECTLY PROPORTIONAL TO THE DISCHARGE RATE OF WATER FROM THE SYSTEM.
7. POND VOLUME IS INVERSELY PROPORTIONAL TO THE MASS OF THE DESIGN SIZE SUSPENDED PARTICLE.
8. A SYSTEM MUST PROVIDE SUFFICIENT FLOW TO ALLOW FOR DEPOSITION OF DESIGN SIZE PARTICLES.
9. THE PONDING HEIGHT MUST BE WELL BELOW THE GROUND ELEVATION DOWNSLOPE TO PREVENT RUNOFF FROM BYPASSING THE INLET. A TEMPORARY DIKE MAY BE NECESSARY ON THE DOWNSLOPE SIDE OF THE STRUCTURE.

**ROCK BAG / FILTER MAT DROP INLET SEDIMENT BARRIER**

**STORM WATER QUALITY  
MANAGEMENT DIVISION**

ERIC J. WENGER, P.E.  
CITY ENGINEER  
DATE: 03-06-13  
DRAWN: VSC  
DATE: 03-06-13



**The City of  
Oklahoma City  
Public Works Department  
Engineering Division**

**FORM  
7.10**



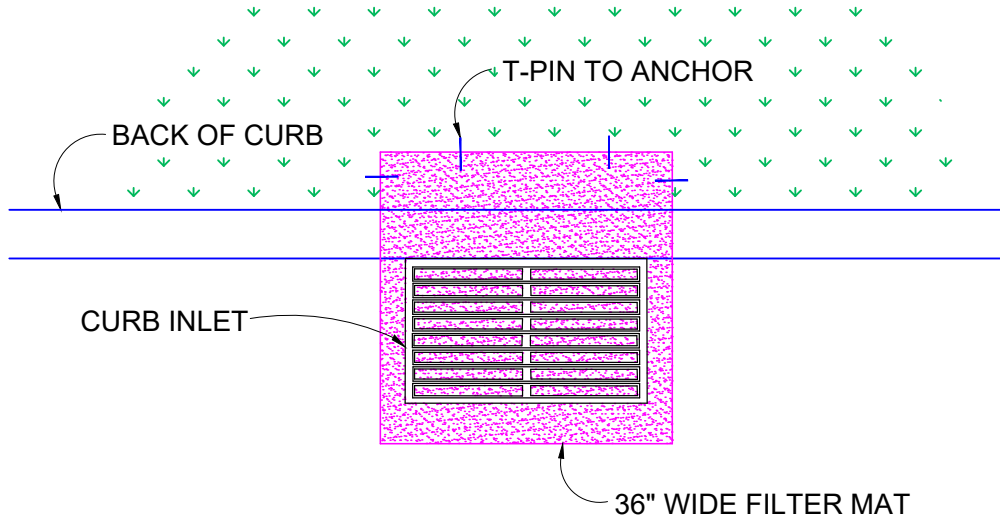

**PLAN VIEW**

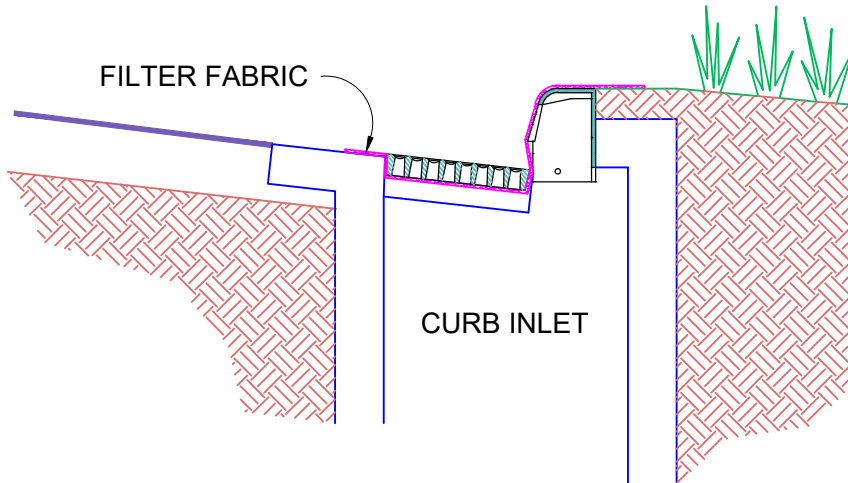

**NOTES:**

1. USE FILTER MAT SEDIMENT BARRIER WHEN CURB INLET IS LOCATED IN GENTLY SLOPING STREET, WITH MINIMAL NEED, WHERE WATER CAN FILTER AND ALLOW SEDIMENT TO SEPARATE FROM RUNOFF.
2. BARRIER SHALL ALLOW FOR OVERFLOW FROM SEVERE STORM EVENT.
3. INSPECT BARRIERS AND REMOVE SEDIMENT AFTER EACH STORM EVENT. SEDIMENT MUST BE REMOVED FROM THE TRAVELED WAY IMMEDIATELY.

**CURB INLET FILTER MAT SEDIMENT BARRIER**

STORM WATER QUALITY  
MANAGEMENT DIVISION

ERIC J WENGER, P.E. DATE: 03-06-13  
CITY ENGINEER  
DRAWN: VSC  
DATE: 03-06-13



The City of  
**Oklahoma City**  
Public Works Department  
Engineering Division

FORM  
7.11

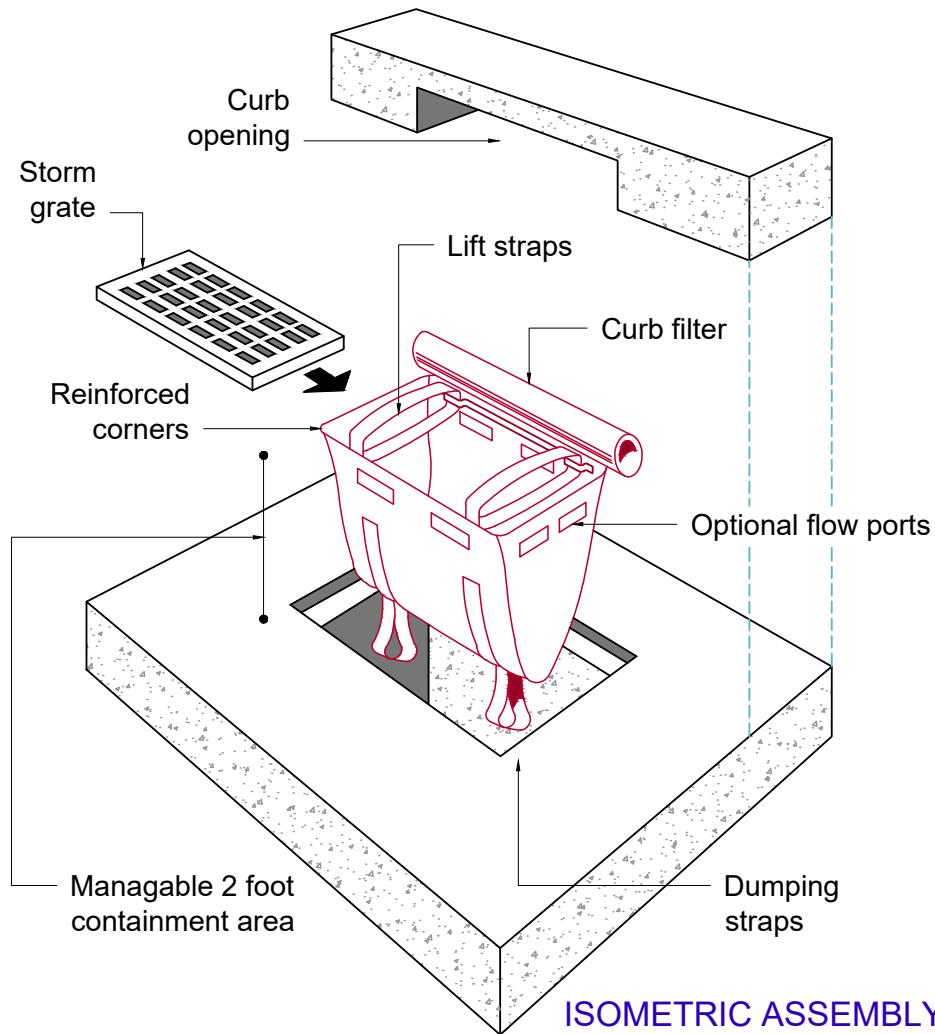

**ISOMETRIC ASSEMBLY**

**NOTES:**

1. Remove the grate from the catch basin.
2. Stand grate on end. Move the top lifting straps out of the way and place grate into the unit so that the grate is below the top straps and above the lower straps. The grate should be cradled between the upper and lower straps.
3. Holding the lifting straps, insert the grate into the inlet, being careful that the grate remains in place and being careful not to damage the unit.
4. Remove all accumulated sediment and debris from the vicinity of unit after each storm event.
5. After each storm event and at regular intervals, look into the unit. If the unit is more than 1/3 full of accumulated sediment, the unit must be emptied.
6. To empty the unit, using the lifting straps lift the unit out of the inlet and remove the grate. Transport the unit to an appropriate location for removal of contents. Holding the dumping straps on the bottom of the unit, turn the unit upside down, emptying the contents. Reinstall unit as above.

**CURB INLET SEDIMENT BAG**

**STORM WATER QUALITY  
MANAGEMENT DIVISION**

ERIC J. WENGER, P.E.  
CITY ENGINEER  
DATE: 03-06-13  
DRAWN: VSC  
DATE: 03-06-13



**The City of  
Oklahoma City  
Public Works Department  
Engineering Division**

**FORM  
7.12**

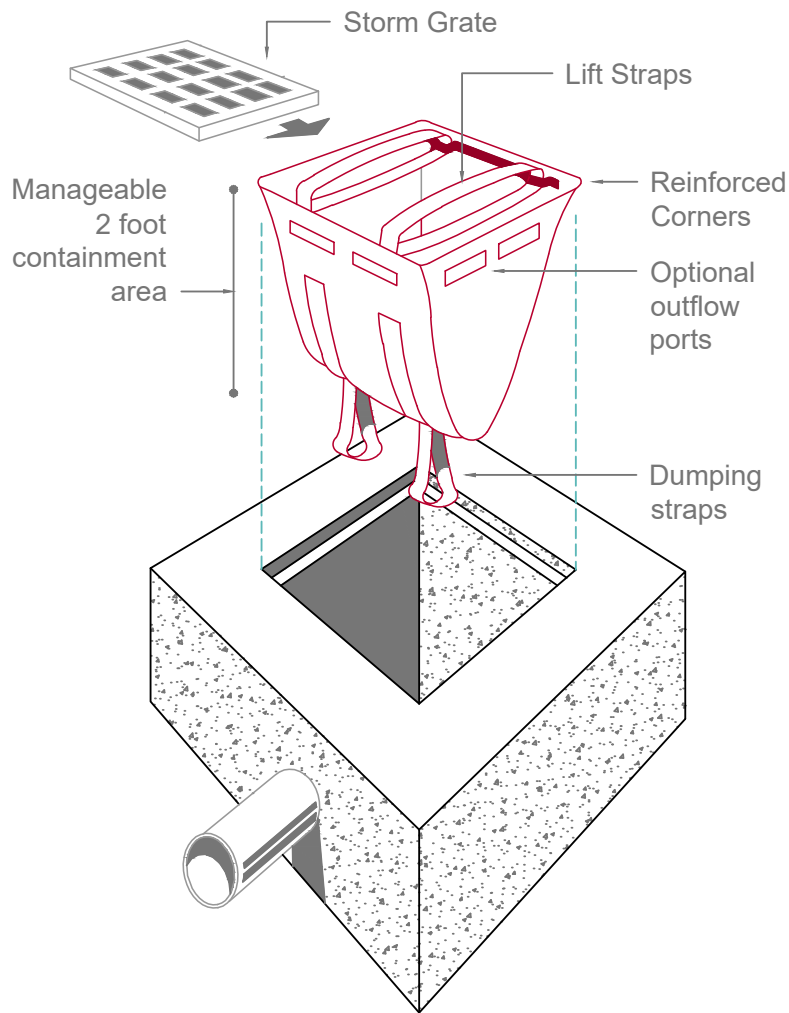

### ISOMETRIC ASSEMBLY

**NOTES:**

1. Remove the grate from the catch basin.
2. Stand grate on end. Move the top lifting straps out of the way and place grate into the unit so that the grate is below the top straps and above the lower straps. The grate should be cradled between the upper and lower straps.
3. Holding the lifting straps, insert the grate into the inlet, being careful that the grate remains in place and being careful not to damage the unit.
4. Remove all accumulated sediment and debris from the vicinity of unit after each storm event.
5. After each storm event and at regular intervals, look into the unit. If the unit is more than 1/3 full of accumulated sediment, the unit must be emptied.
6. To empty the unit, using the lifting straps lift the unit out of the inlet and remove the grate. Transport the unit to an appropriate location for removal of contents. Holding the dumping straps on the bottom of the unit, turn the unit upside down, emptying the contents. Reinstall unit as above.

### DROP INLET SEDIMENT BAG

STORM WATER QUALITY  
MANAGEMENT DIVISION

|                                                                                                                              |                |
|------------------------------------------------------------------------------------------------------------------------------|----------------|
| <br>ERIC J. WENGER, P.E.<br>CITY ENGINEER | DATE: 03-06-13 |
| DRAWN:                                                                                                                       | VSC            |
| DATE:                                                                                                                        | 03-06-13       |



The City of  
**Oklahoma City**  
Public Works Department  
Engineering Division

FORM  
7.13

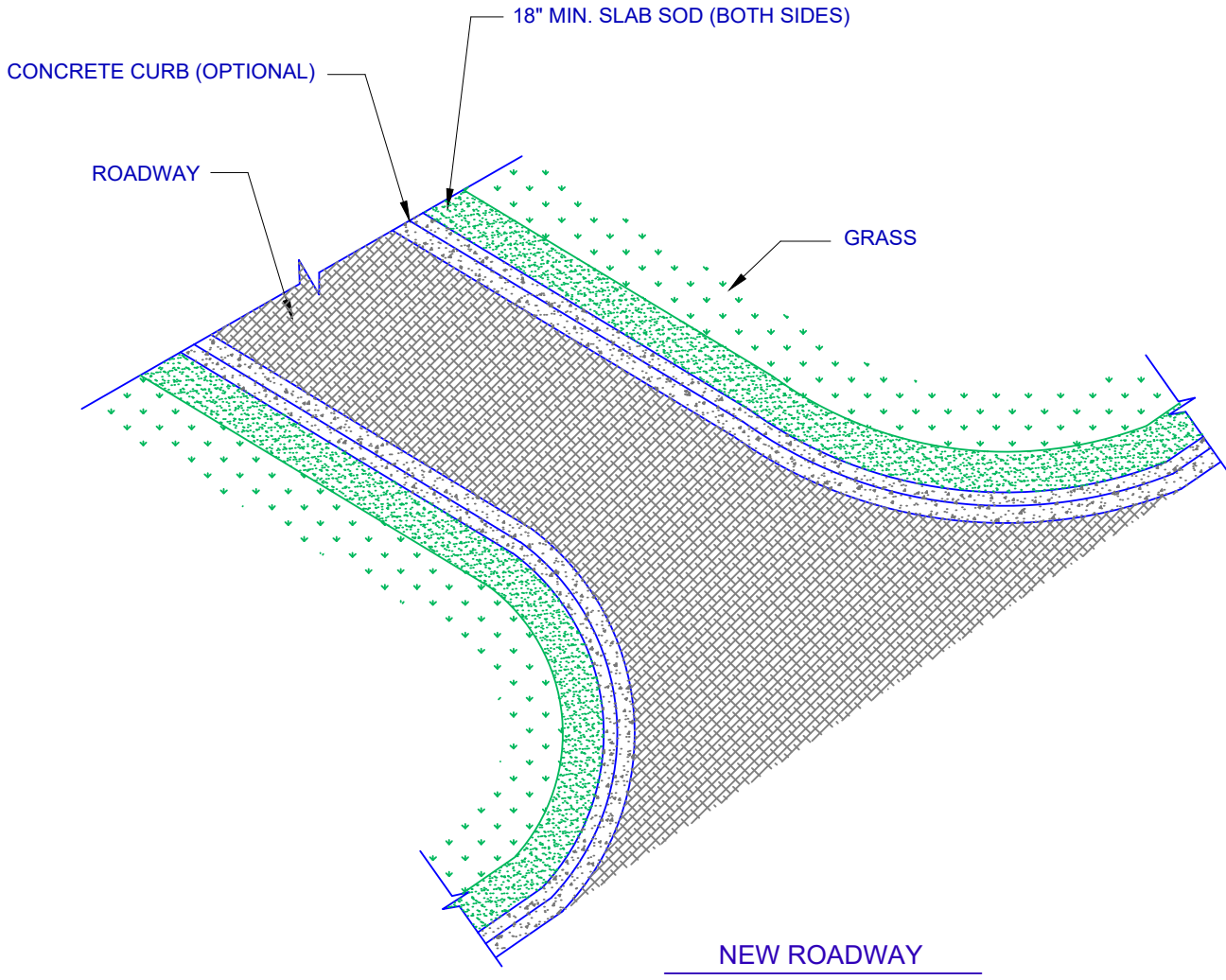

**NEW ROADWAYS**

STORM WATER QUALITY  
MANAGEMENT DIVISION

ERIC J. WENGER, P.E.  
CITY ENGINEER

DATE: 03-07-13

DRAWN: VSC

DATE: 03-07-13



The City of  
**Oklahoma City**  
Public Works Department  
Engineering Division

FORM  
7.14

E:\CITY\AG\2008\5114\Storm Water Quality Manual\FORM 7.14 VSC 03/07/13

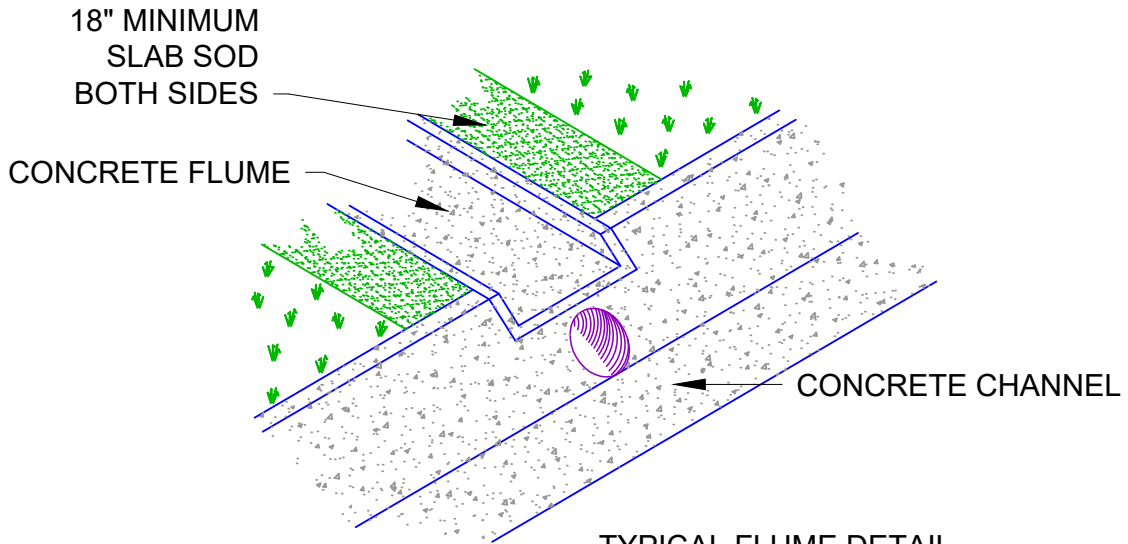

TYPICAL FLUME DETAIL  
CONCRETE CHANNEL

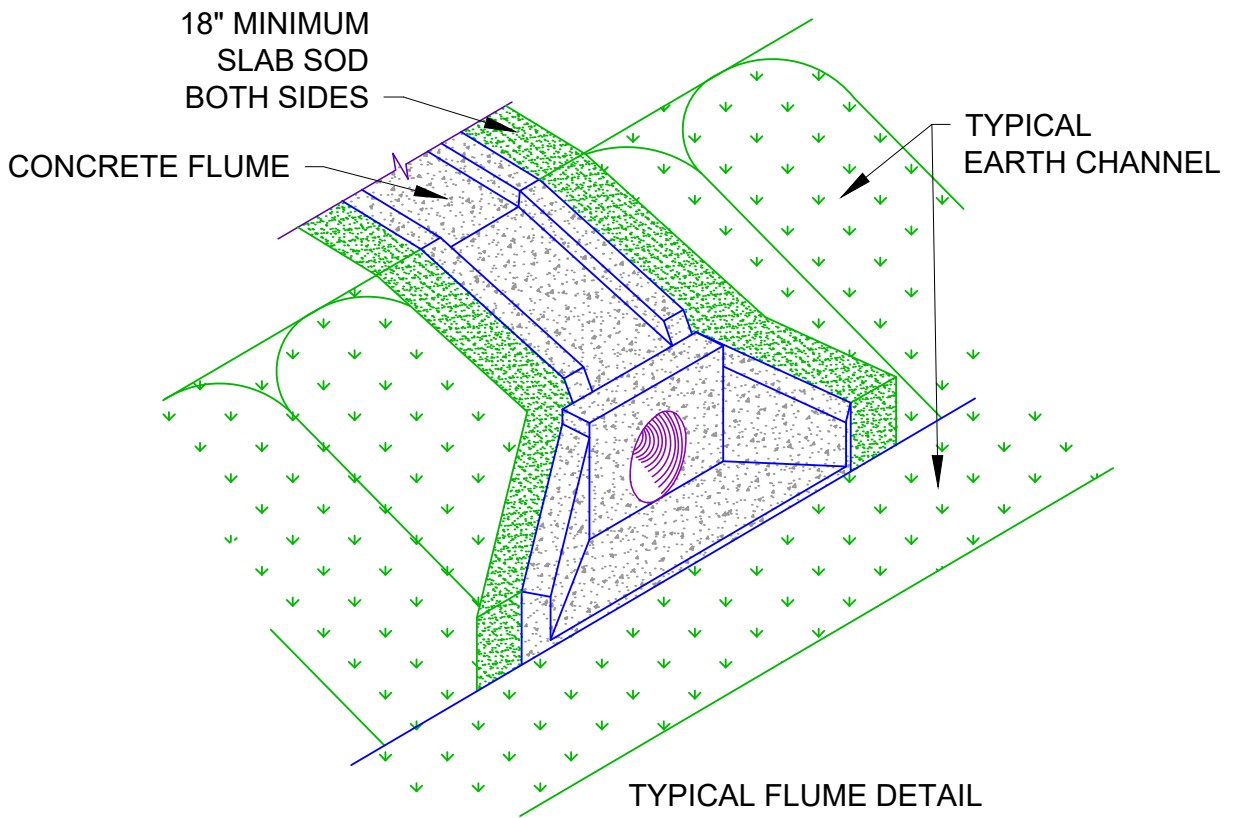

TYPICAL FLUME DETAIL  
EARTH CHANNEL

**CONCRETE FLUME**

STORM WATER QUALITY  
MANAGEMENT DIVISION

ERIC J. WENGER, P.E.  
CITY ENGINEER  
DATE: 03-07-13  
DRAWN: VSC  
DATE: 03-07-13



The City of  
Oklahoma City  
Public Works Department  
Engineering Division

FORM  
7.15

MATS / BLANKETS SHOULD BE INSTALLED VERTICALLY DOWN SLOPE

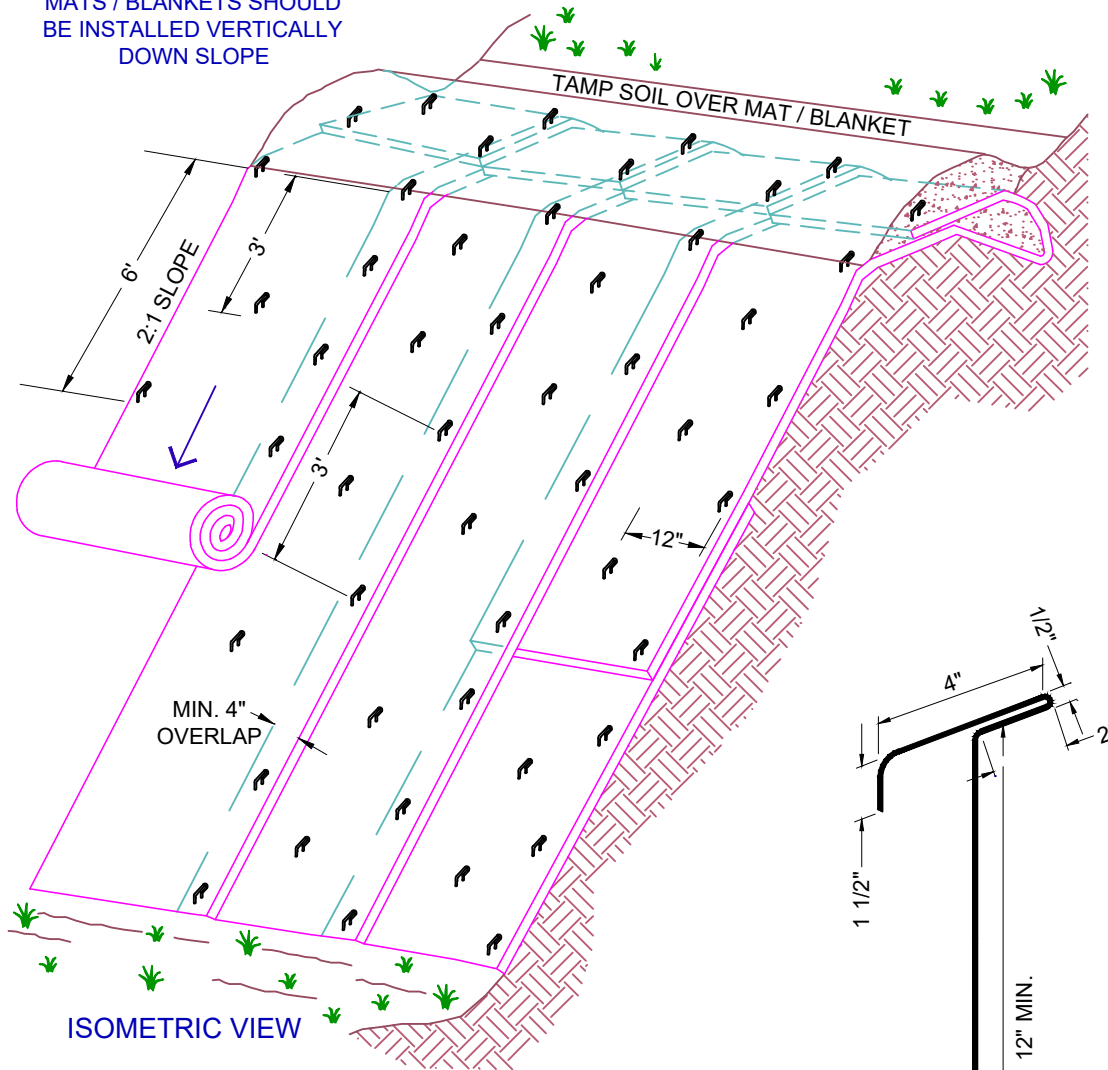

ISOMETRIC VIEW

TYPICAL SLOPE SOIL STABILIZATION

NOTES:

1. SLOPE SURFACE SHALL BE FREE OF ROCKS CLODS, STICKS AND GRASS. MATS / BLANKETS SHALL HAVE GOOD SOIL CONTACT.
2. APPLY PERMANENT SEEDING BEFORE PLACING BLANKETS.
3. LAY BLANKETS LOOSELY AND STAKE OR STAPLE TO MAINTAIN DIRECT CONTACT WITH THE SOIL. DO NOT STRETCH.

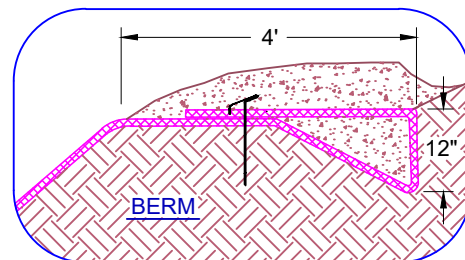
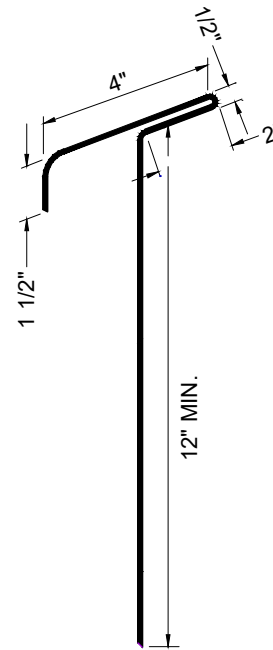

**EROSION BLANKET & TURF REINFORCEMENT MATS - SLOPE INSTALLATION**

STORM WATER QUALITY  
MANAGEMENT DIVISION

ERIC J WENGER, P.E.  
CITY ENGINEER  
DATE: 03-07-13  
DRAWN: VSC  
DATE: 03-07-13



The City of  
**Oklahoma City**  
Public Works Department  
Engineering Division

FORM  
7.16

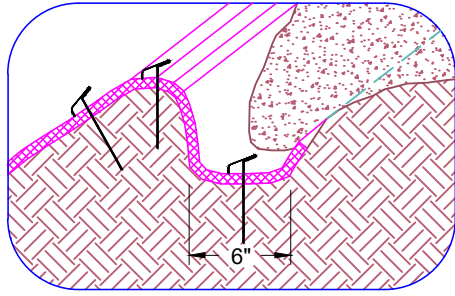

LONGITUDINAL ANCHOR TRENCH

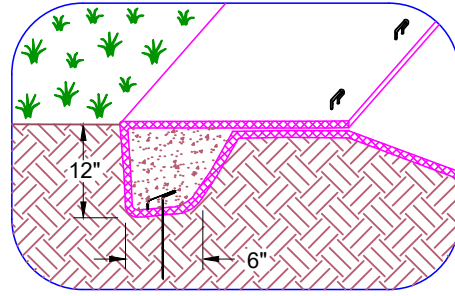

TERMINAL SLOPE AND CHANNEL ANCHOR TRENCH

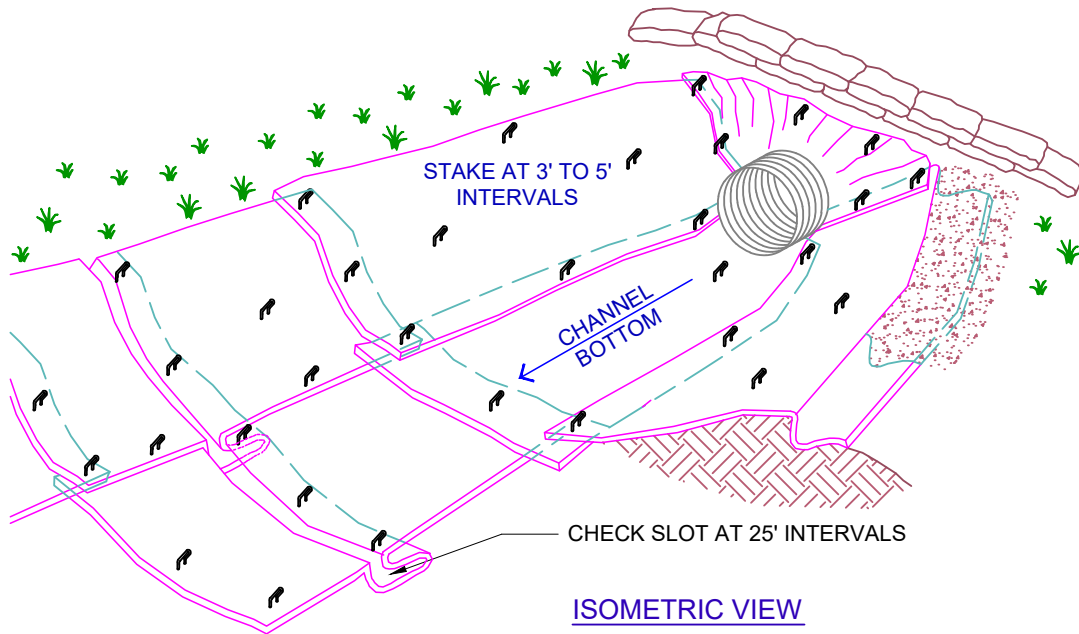

ISOMETRIC VIEW

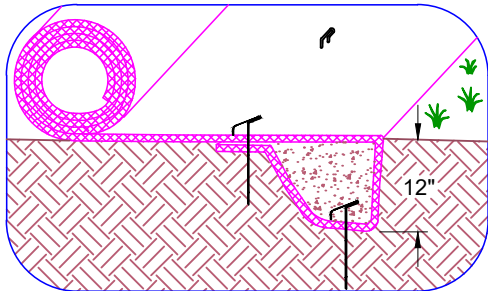

INITIAL CHANNEL ANCHOR TRENCH

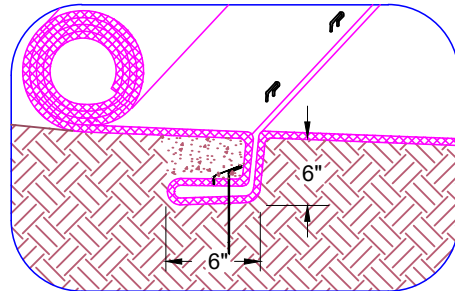

INTERMITTENT CHECK SLOT

**NOTES:**

1. CHECK SLOTS TO BE CONSTRUCTED PER MANUFACTURE'S SPECIFICATIONS.
2. STAKING OF STAPLING LAYOUT PER MANUFACTURES SPECIFICATIONS.

**EROSION BLANKET & TURF REINFORCEMENT MATS - CHANNEL INSTALLATION**

STORM WATER QUALITY  
MANAGEMENT DIVISION

ERIC J. WENGER, P.E.  
CITY ENGINEER  
DATE: 03-07-13  
DRAWN: VSC  
DATE: 03-07-13



The City of  
Oklahoma City  
Public Works Department  
Engineering Division

FORM  
7.17

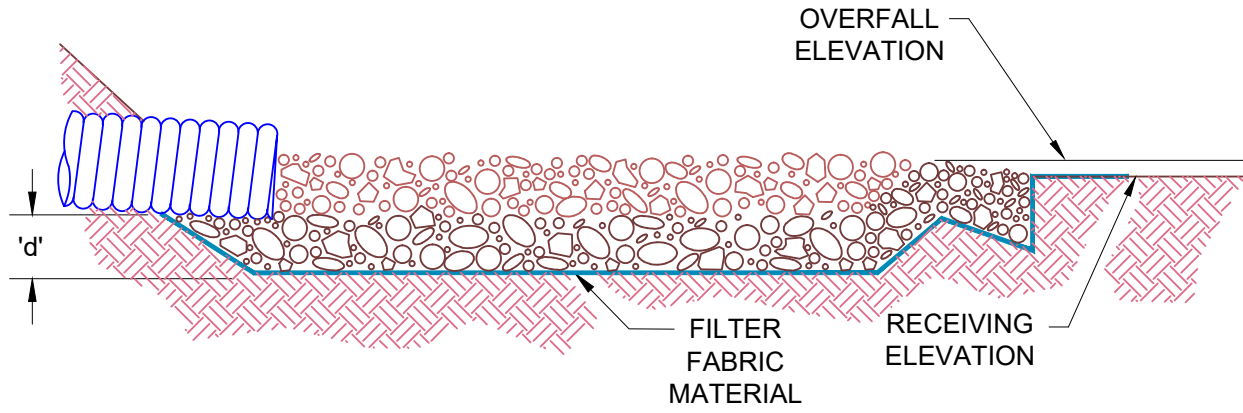

THICKNESS ('d') = 1.5 x MAXIMUM DIAMETER - 6" MINIMUM

SECTION

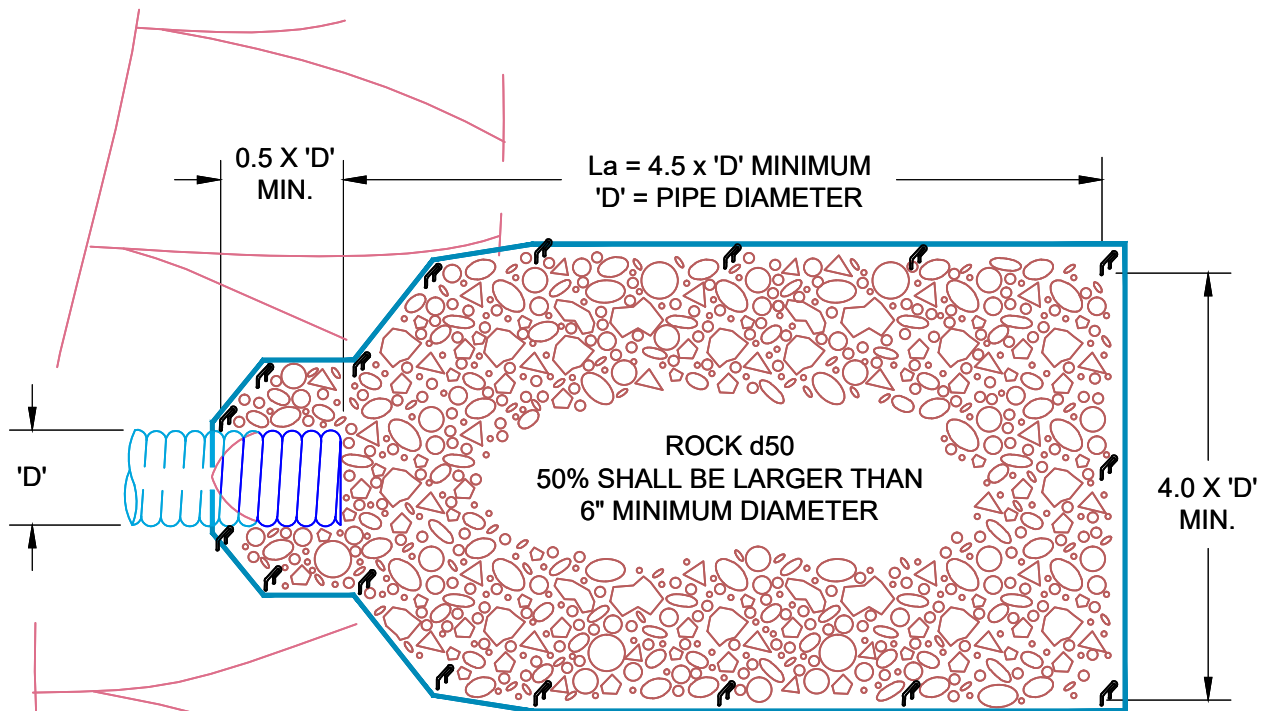

PLAN

NOTES:

1. 'La' = LENGTH OF APRON. DISTANCE 'La' SHALL BE OF SUFFICIENT LENGTH TO DISSIPATE ENERGY.
2. APRON SHALL BE AT A ZERO GRADE AND ALIGNED STRAIGHT.
3. FILTER MATERIAL SHALL BE FILTER FABRIC.

**ENERGY DISSIPATER**

STORM WATER QUALITY  
MANAGEMENT DIVISION

ERIC J. WENGER, P.E.  
CITY ENGINEER  
DATE: 03-08-13  
DRAWN: VSC  
DATE: 03-08-13



The City of  
Oklahoma City  
Public Works Department  
Engineering Division

FORM  
7.18



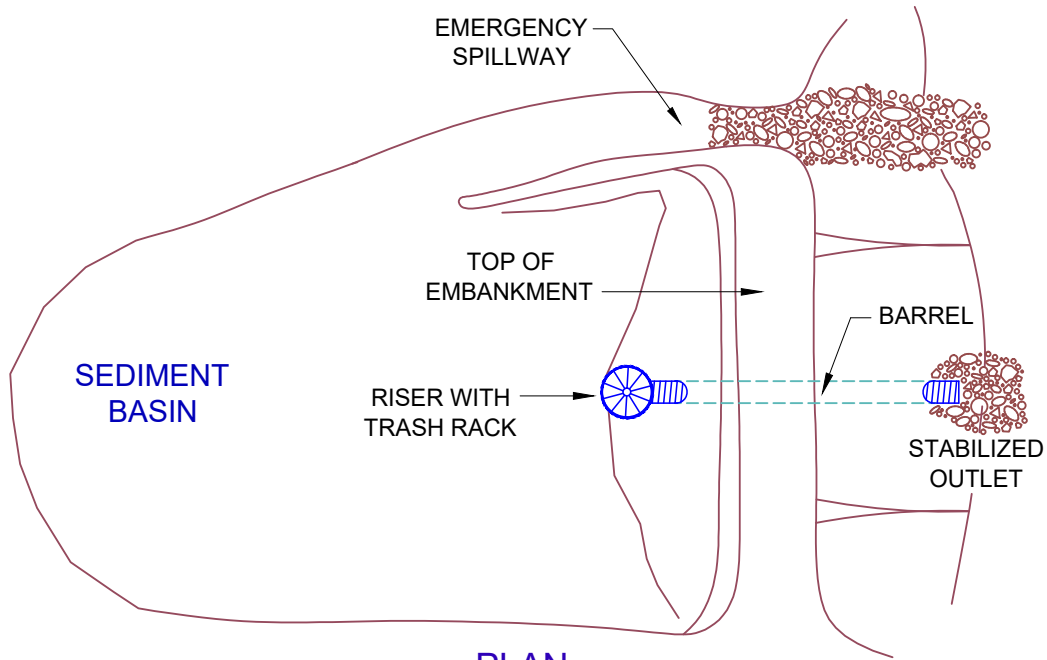

PLAN

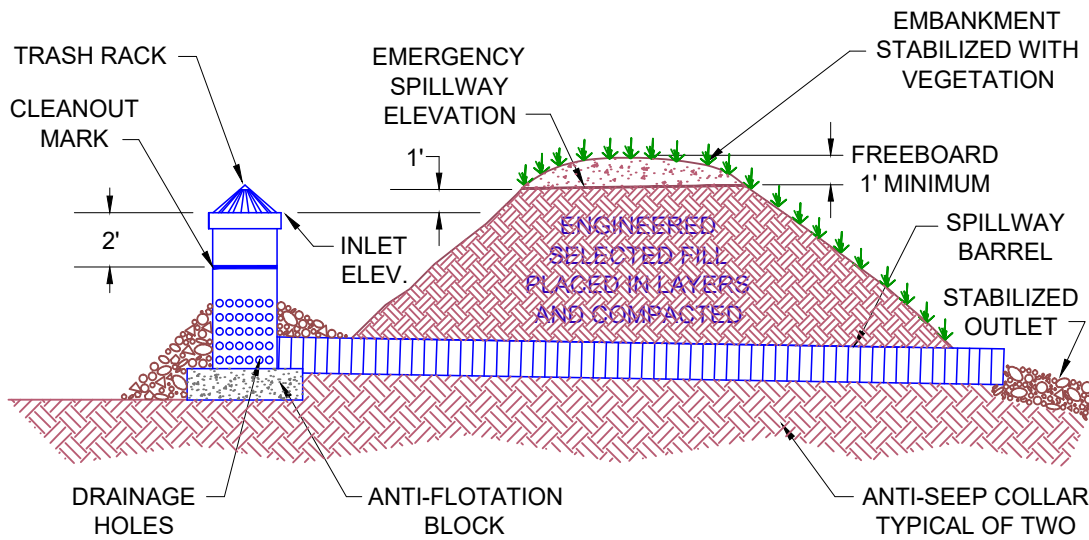

SECTION

**NOTES:**

1. THE TEMPORARY SEDIMENT BASIN, DESIGNED BY A QUALIFIED PROFESSIONAL, IS REQUIRED FOR DISTURBED AREAS GREATER THAN 5 ACRES WITHIN A DRAINAGE AREA LESS THAN 100 ACRES.
2. ACCUMULATED SEDIMENT SHALL BE CLEANED OUT WHEN BASIN REACHES APPROXIMATELY, 50% CAPACITY.
3. THE SEDIMENT BASIN WILL BE REMOVED WITHIN THREE YEARS.

**TYPICAL SEDIMENT BASIN**

STORM WATER QUALITY  
MANAGEMENT DIVISION

|                                      |                |
|--------------------------------------|----------------|
| ERIC J WENGER, P.E.<br>CITY ENGINEER | DATE: 03-08-13 |
| DRAWN: VSC                           |                |
| DATE: 03-08-13                       |                |



The City of  
**Oklahoma City**  
Public Works Department  
Engineering Division

FORM  
7.19

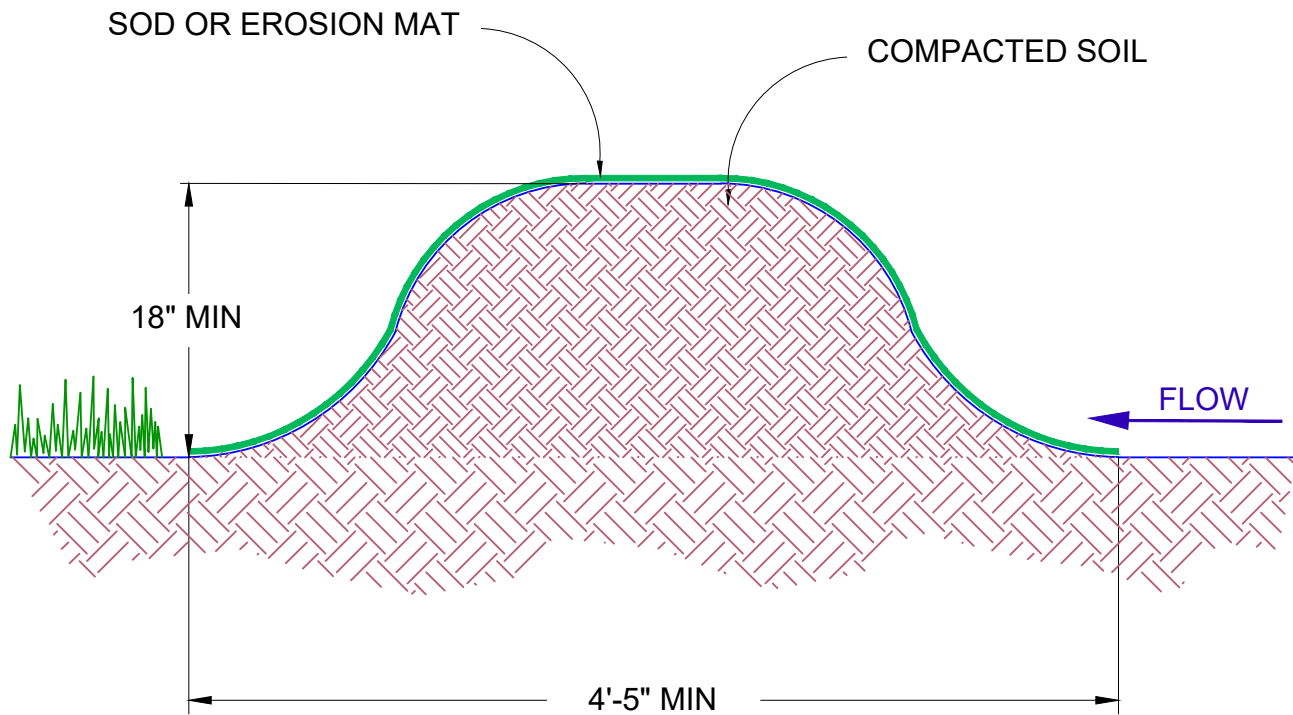

### TYPICAL EARTH DIKE

**NOTES:**

1. INSPECT AND REPAIR EARTH DIKE AFTER EACH STORM EVENT AND REMOVE SEDIMENT WHEN NECESSARY.
2. REMOVED SEDIMENT SHALL BE DEPOSITED TO AN AREA THAT WILL NOT CONTRIBUTE SEDIMENT OFF-SITE AND CAN BE PERMANENTLY STABILIZED.
3. STABILIZE BERM WITH SOD OR EROSION BLANKETS.

### **TYPICAL EARTH DIKE**

**STORM WATER QUALITY  
MANAGEMENT DIVISION**

ERIC J. WENGER, P.E.  
CITY ENGINEER

DATE: 03-08-13

DRAWN: VSC

DATE: 03-08-13



**The City of  
Oklahoma City  
Public Works Department  
Engineering Division**

**FORM  
7.20**

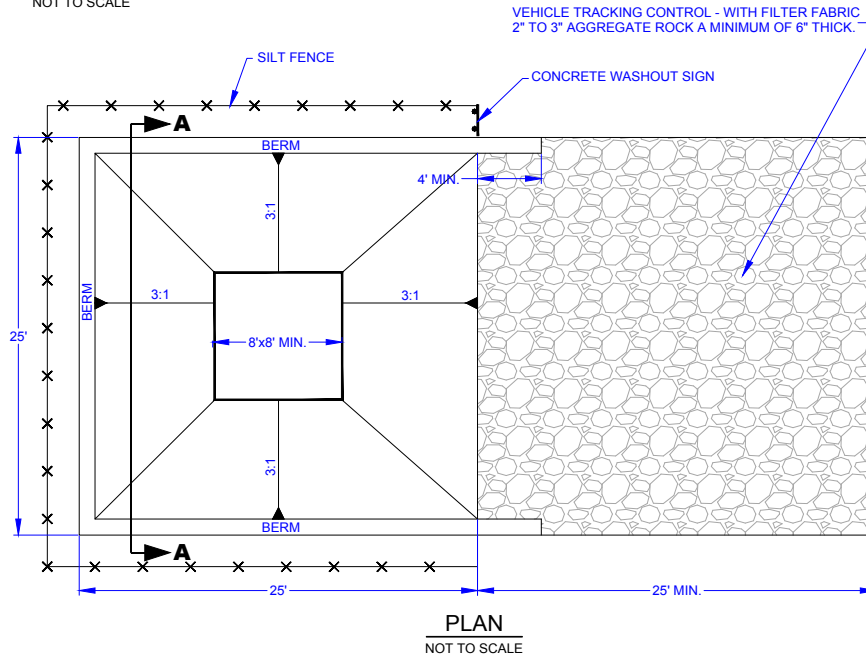
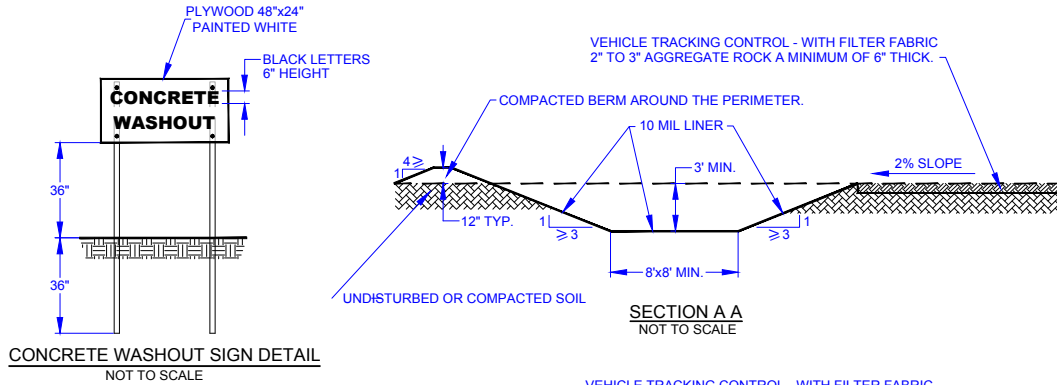

**NOTES:**

1. CWA shall be installed prior to concrete placement.
2. See plan view for CWA installation location. The location of all concrete washout structures must be constructed with a minimum setback dimensions of 5 feet above groundwater, and 50 feet from the top of bank of perennial stream, other surface water body, or wetland.
3. CWA must be installed with a low permeable polypropylene or polyethylene geomembrane with a minimum 10-mil thickness.
4. CWA shall include a flat subsurface pit that is at least 8' x 8' with the slopes leading out of the subsurface pit being 3:1 or flatter. The pit shall be at least 3' deep
5. Vehicle tracking pad shall be sloped towards the CWA and shall be constructed with a filter fabric under 2" to 3" aggregate rock a minimum of 6" thick.
6. Signs shall be placed at the construction entrance, at the CWA and elsewhere as necessary to clearly indicate the location of the CWA to operators of concrete trucks and pump rigs.
7. Use excavated material for perimeter berm.

**SUBSURFACE CONCRETE WASHOUT AREA**

STORM WATER QUALITY  
MANAGEMENT DIVISION

ERIC J. WENGER, P.E.  
CITY ENGINEER

DATE: \_\_\_\_\_

DRAWN: TVN

DATE: 02-23-18



The City of  
Oklahoma City  
Public Works Department  
Engineering Division

FORM  
7.21

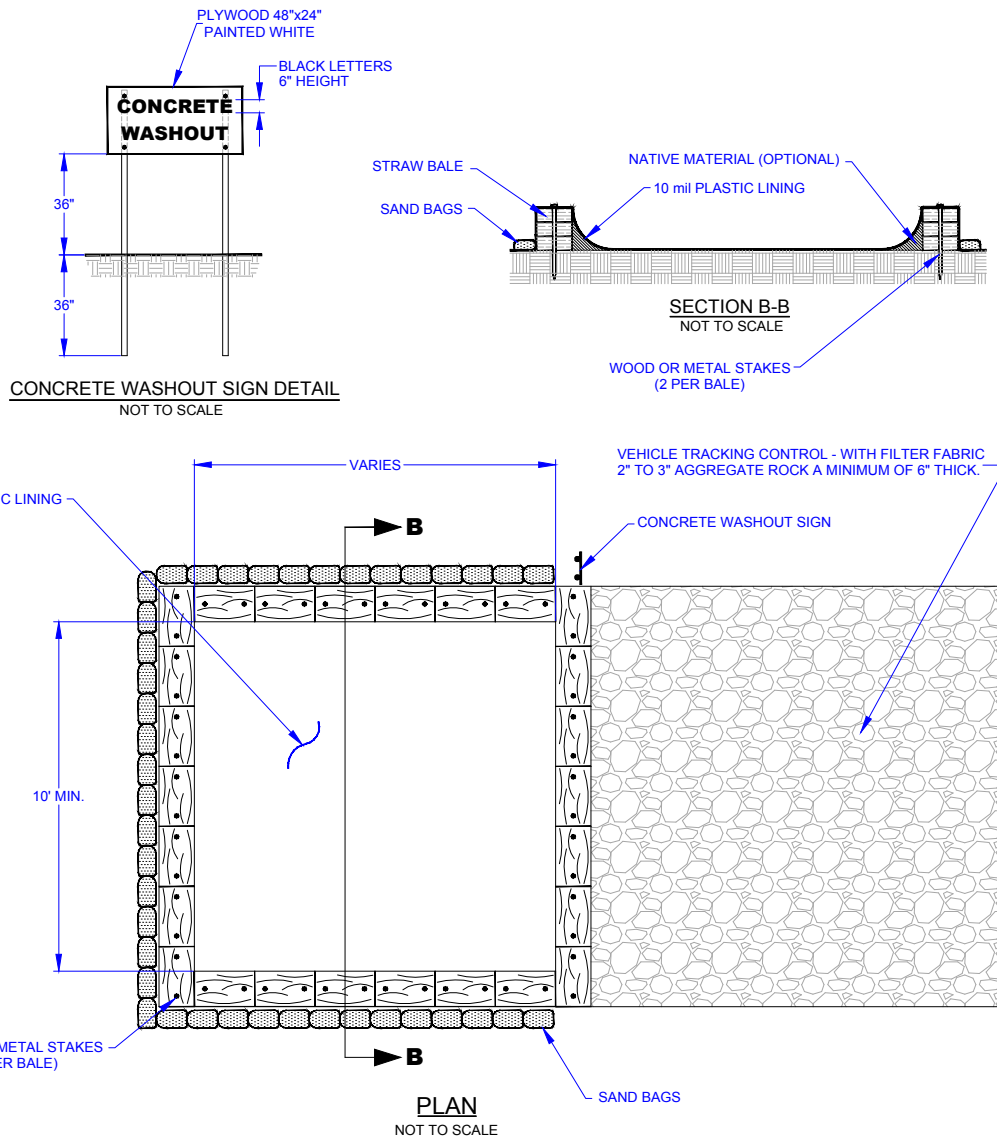

**Notes:**

1. CWA shall be installed prior to concrete placement.
2. See plan view for CWA installation location. The location of all concrete washout structures must be constructed with a minimum setback dimensions of 5 feet above groundwater, and 50 feet from the top of bank of perennial stream, other surface water body, or wetland.
3. CWA shall include a flat surface pit that is at least 10' x 10' with the walls built of haybales end to end double staked into the ground.
4. CWA must be installed with a low permeable polypropylene or polyethylene geomembrane with a minimum 10-mil thickness.
5. Vehicle tracking pad shall be sloped towards the CWA and shall be constructed with a filter fabric under 2" to 3" aggregate rock a minimum of 6" thick.
6. Signs shall be placed at the construction entrance, at the CWA and elsewhere as necessary to clearly indicate the location of the CWA to operators of concrete trucks and pump rigs

**ABOVE GROUND CONCRETE WASHOUT AREA**

**STORM WATER QUALITY  
MANAGEMENT DIVISION**

ERIC J. WENGER, P.E.  
CITY ENGINEER

DATE: \_\_\_\_\_

DRAWN: TVN

DATE: 02-23-18



The City of  
**Oklahoma City**  
Public Works Department  
Engineering Division

**FORM  
7.22**

C:\THINH\Drawing\PHILLIPS D\SILT SOCK INSTALLATION.dwg, 5/7/2018 9:41:07 AM, DWG To PDF.pc3

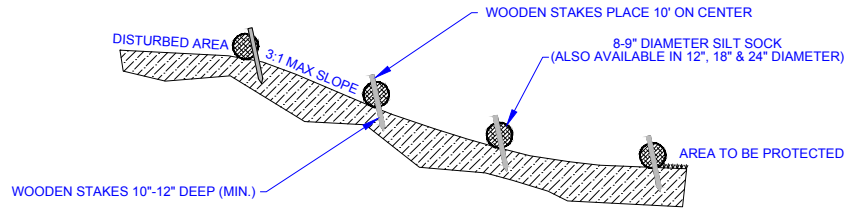

**SLOPE INTERRUPTION**

- 1- A LIGHT ENTRENCHMENT MAY BE REQUIRED ON STEEPER SLOPES
- 2- REMOVE SEDIMENT FROM THE UP SLOPE SIDE OF THE SILT SOCK WHEN ACCUMULATION HAS REACHED 1/2 OF EFFECTIVE HEIGHT OF SOCK.
- 3- LOOSE FILTER MEDIA MAY BE BACKFILLED ON THE UP SLOPE SIDE OF SOCK TO ENHANCE PERFORMANCE.
- 4- HARDWOOD STAKES 2"x2"x24" (NOMINAL) ARE SUGGESTED.

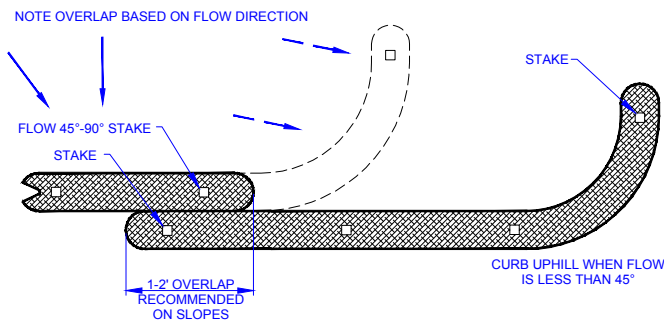

**PERIMETER CONTROL & OVERLAPPING**

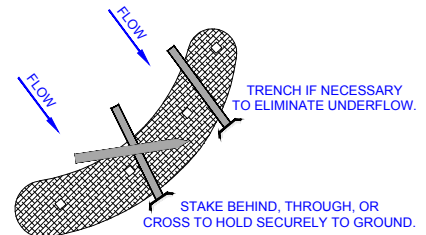

**DITCH CHECK**

INSTALL SILT SOCK PERPENDICULAR TO FLOW WITH ENDS CURLED SLIGHTLY UPSTREAM TO PREVENT HIGH WATER FROM GOING AROUND THE ENDS. SLOW AND SPREAD WATER TO REDUCE CHANNELING AND EROSION.

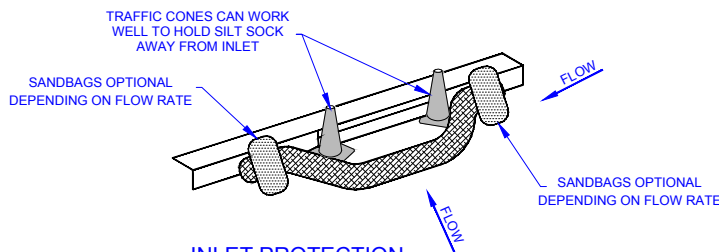
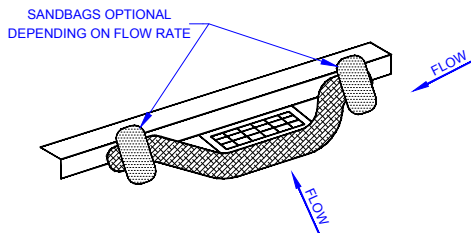

**INLET PROTECTION**

FILTER OUT SEDIMENT ON SLOWER FLOW. ALLOW HIGH WATER TO TOP OVER & ESCAPE.

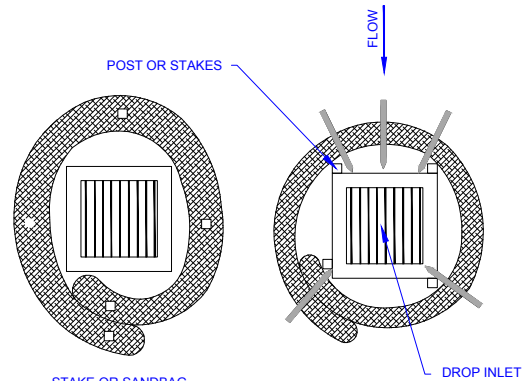

**DROP INLET PROTECTION**

ANGLE STAKES IN TO SQUEEZE SOCK AGAINST POST & GROUND STACK OR PYRAMID SOCK FOR MORE HEIGHT DEPENDING ON FLOW.

**NOTES:**

1. THESE GUIDELINES ARE BASED UPON MANUFACTURERS RECOMMENDATIONS. PROJECT SPECIFICATIONS MAY SUPERSEDE THESE GUIDELINES.
2. REFER TO REGULATORY AUTHORITY OR PROJECT ENGINEER FOR DETAILED INSTALLATION PROCEDURES.
3. WOOD FILLER MATERIAL IS PROPERLY SIZE, BIODEGRADABLE, WEED, SEED & DISEASE FREE AND ENVIRONMENTALLY SOUND.

**SILT SOCK INSTALLATION**

STORM WATER QUALITY  
MANAGEMENT DIVISION

*Eric J. Wenger* DATE: 05-05-18  
ERIC J. WENGER, P.E.  
CITY ENGINEER  
DRAWN: TVN  
DATE: 04-03-18



The City of  
Oklahoma City  
Public Works Department  
Engineering Division

FORM  
7.23

# 8

## OTHER BMPs

### **8. Other BMPs**

- 8.1 Hydromulching
- 8.2 Coagulation and Flocculation
- 8.3 Temporary Above Ground Storage Tanks (ASTs)

## 8.1 Hyromulching

Hydromulching is the process of applying a slurry of water, shredded wood fiber or hydraulic matrix, seed and often a stabilizing emulsion/tackifier, which temporarily protects soils from erosion by water and wind. Hydroseeding is the process of applying a slurry of water, shredded wood fiber or hydraulic matrix, seed and fertilizer provide an environment conducive to plant growth.

Hydromulching is applied to denuded areas requiring temporary protection until permanent vegetation is established or disturbed areas that must be re-disturbed following an extended period of inactivity. Often these areas are steep or highly erosive slopes which have been partially or completely denuded of vegetation due to land disturbance.

Advantages:

- Provides immediate protection of soil
- Reduces sheet and rill erosion.
- Prevents soil compaction and crusting and facilitates rainfall infiltration
- Organic matter improves soil fertility and structure

### Standards and Specifications

To select appropriate hydroseeding mixtures, an evaluation of site conditions shall be performed with respect to:

- Soil condition
- Site topography
- Season and climate
- Vegetation types
- Maintenance requirements
- Sensitive adjacent areas
- Water availability
- Plans for permanent vegetation



### Maintenance and Inspection

All seeded areas shall be inspected for failures and reseeded, fertilized and mulched within the planting season, using not less than half the original rates.

## 8.2 Coagulation and Flocculation

**Coagulation** is the process by which particles are destabilized by neutralizing their electric charge, which allows particle agglomeration to occur.

**Flocculation** is the process of physical bridging of particles, which relies on the size of the flocculent molecule, rather than charge neutralization.

For many years construction sites have relied on erosion controls that used passive gravitational settling methods to remove suspended material from storm water runoff. As stricter regulations are implemented around the nation, using an active treatment system that uses coagulation and/or a flocculation system has become a viable option to improve efficiency and water quality. Although polymers have been used for many years in industrial and other applications, their application to storm water is relatively new.

Storm water runoff from construction sites generally will contain suspended solids, which are particles that are not dissolved in water. While dense particles such as sand and courser materials can be effectively removed by simple gravity, finer materials are often difficult to remove by settling alone. Sediment settling is improved when particle diameters are increased. The primary processes for increasing particle diameter to allow efficient settling are coagulation and flocculation.

Turbidity refers to how clear the water is. The greater the amount of total suspended solids (TSS) in the water, the murkier it appears and the higher the measured turbidity. Turbidity is often reported in nephelometric turbidity units (NTUs) which refers to the type of instrument (turbidimeter or nephelometer) used for estimating light scattering from suspended particulate material.

Turbidity can be useful as an indicator of the effects of runoff from construction, agricultural and discharges from other sources. Turbidity often increases sharply during a rainfall, especially in developed watersheds, which typically have relatively high proportions of impervious surfaces. The flow of storm water runoff from impervious surfaces rapidly increases stream velocity, which can increase the erosion rates of streambanks and channels. Turbidity can also rise sharply during dry weather if earth-disturbing activities are occurring in or near a stream without erosion control practices in place.

One of the major effects turbidity has on humans might be simply aesthetic – people don't like the look of dirty water. However, turbidity also adds real costs to the treatment of surface water supplies used for drinking water since the turbidity must be virtually eliminated for effective disinfection (usually by chlorine in a variety of forms) to occur. Particulates also provide attachments such as toxic organic contaminants such as PCBs, PAHs and many pesticides.

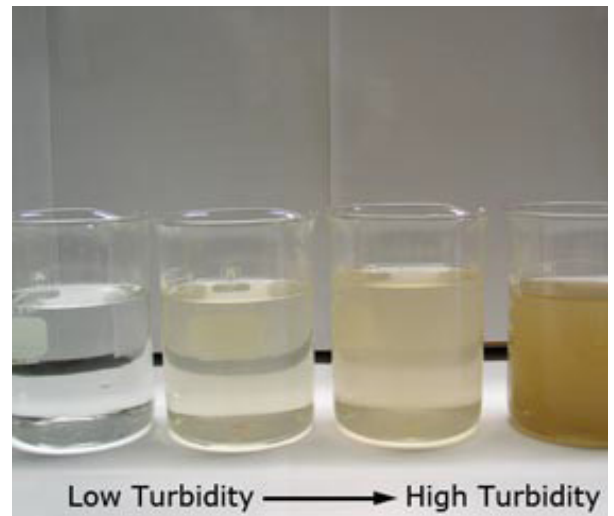



Finally, EPA states that storm water runoff from construction activities can have a significant impact on water quality. As storm water flows over a construction site, it can pick up pollutants like sediment, debris, and chemicals and transport these to a nearby storm sewer system or directly to creeks, rivers or lakes. Polluted storm water runoff can harm or kill fish and other wildlife. Sedimentation can destroy aquatic habitat, and high volumes of runoff can cause stream bank erosion and channel turbidity.



### 8.3 Temporary Above Ground Storage Tanks (ASTs)

Any petroleum product that is spilled can pose a serious threat to human health and the environment, and may require remediation, and result in substantial clean-up cost. Even a small pint of oil released into water can cover one acre of water surface, also an oil spill of only one gallon can contaminate a million gallons of water, therefore the location of an AST must be considered in relation to streams, ponds, ditches, storm sewers, and wetlands.

#### Best Management Practices for ASTs

1. Place ASTs at least 50 feet away from streams, ponds, ditches, storm sewers, or wetlands.
2. Provide secondary containment around ASTs. Secondary containment must be able to contain 110% of the volume of the fuel storage tank and should be impermeable to the materials being stored. Methods include berms, dikes, liners and double walled tanks.
3. Store and maintain appropriate spill cleanup materials in a location known to all employees, near the fueling operation and train employees on proper spill cleanup procedures.
4. Instruct employees in all aspects of proper storage and handling of fuel and other petroleum products. Instruct employees to be present during all fuel transfers, and immediately clean up spills and contaminated soil.
5. Immediately report significant spills of 25 gallons or more or when there is an impact or potential impact on streams, ponds, ditches, storm sewers, or wetlands.
  - DEQ 24-hour Hotline 1-800-522-0206
  - National Response Center 1-800-424-8802 (if there is a sheen or threat of a sheen on navigable waterways)
6. Inspect fueling areas and storage tanks regularly for damages or leaks.
7. Fuel storage areas must be kept secure when not in use.



